



02

PUNTE A FISSAGGIO MECCANICO INDEXABLE DRILLS

A.02.01

Guida alla selezione dell'utensile
Tool selection guide

136-140

A.02.02

Gamma prodotti
Products range

141-190

A.02.03

Parametri di taglio
Cutting data

191-201

A
02



PUNTE A FISSAGGIO MECCANICO

INDEXABLE DRILLS

A.02.01

Guida alla selezione dell'utensile
Tool selection guide

Codice Utensile Tool code	Materiale utensile Tool material	Profondità di taglio Cutting depth	Tipologia Type	DIN	Angolo di testa Point angle	Rivestimento Coating	Codolo Shank	Gamma diametri Diameters range	Tolleranza costruttiva Manufacturing tolerance	Material Groups						Pagina utensile Tool page
										P	M	K	N	S	H	

► RECORD AG DRILL 500

Corpi | Bodies

NEW 501D		ACCIAO Steel	1xd	RECORD AG DRILL	ILIX NORM DIN	-	-	1835 E	16 ÷ 32	-	-	-	-	-	-	143
NEW ∅ 503D		ACCIAO Steel	≤3xd	RECORD AG DRILL	ILIX NORM DIN	-	-	1835 E	12 ÷ 40	-	-	-	-	-	-	144
NEW ∅ 505D		ACCIAO Steel	≤5xd	RECORD AG DRILL	ILIX NORM DIN	-	-	1835 E	12 ÷ 40	-	-	-	-	-	-	145
507D		ACCIAO Steel	≤7xd	RECORD AG DRILL	ILIX NORM DIN	-	-	1835 E	12 ÷ 32	-	-	-	-	-	-	146
NEW 510D		ACCIAO Steel	≤10xd	RECORD AG DRILL	ILIX NORM DIN	-	-	1835 E	16 ÷ 32	-	-	-	-	-	-	147

► RECORD AG DRILL 500

Inserti | Inserts

NEW 50PHTF		M.D.I. HM	-	RECORD AG DRILL	ILIX NORM DIN	145°	TiAIN FUTURA	-	16 ÷ 32	-	-	-	-	-	-	152
NEW ∅ 50GMTF		M.D.I. HM	-	RECORD AG DRILL	ILIX NORM DIN	140°	TiAIN FUTURA	-	12 ÷ 40	-	-	-	-	-	-	154
NEW ∅ 50DMTX		M.D.I. HM	-	RECORD AG DRILL	ILIX NORM DIN	140°	TiSiXN	-	12 ÷ 40	-	-	-	-	-	-	154
NEW ∅ 50SMTL		M.D.I. HM	-	RECORD AG DRILL	ILIX NORM DIN	140°	TiN WCC	-	12 ÷ 40	-	-	-	-	-	-	154
NEW ∅ 50CMTF		M.D.I. HM	-	RECORD AG DRILL	ILIX NORM DIN	140°	TiAIN FUTURA	-	12 ÷ 40	-	-	-	-	-	-	154

► RECORD AG DRILL 600

Corpi | Bodies

603D		ACCIAO Steel	≤3xd	RECORD AG DRILL	ILIX NORM DIN	-	-	1835 E	16 ÷ 40	-	-	-	-	-	-	148
-------------	--	-----------------	------	-----------------------	---------------------	---	---	--------	---------	---	---	---	---	---	---	------------

A
02

Codice Utensile Tool code	Materiale utensile Tool material	Profondità di taglio Cutting depth	Tipologia Type	DIN	Angolo di testa Point angle	Rivestimento Coating	Codolo Shank	Gamma diametri Diameters range	Tolleranza costruttiva Manufacturing tolerance	P	M	K	N	S	H	Pagina utensile Tool page
-----------------------------	-------------------------------------	---------------------------------------	-------------------	-----	--------------------------------	-------------------------	-----------------	-----------------------------------	---	---	---	---	---	---	---	------------------------------

► RECORD AG DRILL 600 Corpi | Bodies

605D		ACCIAO Steel	≤5xd	RECORD AG DRILL	ILIX NORM DIN	-	-		16 ÷ 40	-	-	-	-	-	-	149
607D		ACCIAO Steel	≤7xd	RECORD AG DRILL	ILIX NORM DIN	-	-		16 ÷ 40	-	-	-	-	-	-	150

► RECORD AG DRILL 600 Inserti | Inserts

60GMTF		M.D.I. HM	-	RECORD AG DRILL	ILIX NORM DIN	140°	TiAIN FUTURA	-	16 ÷ 40	-	-	-	-	-	-	157
60DMTX		M.D.I. HM	-	RECORD AG DRILL	ILIX NORM DIN	140°	TiSiXN	-	16 ÷ 40	-	-	-	-	-	-	157
60SMTL		M.D.I. HM	-	RECORD AG DRILL	ILIX NORM DIN	140°	TiN WCC	-	16 ÷ 40	-	-	-	-	-	-	157
60CMTF		M.D.I. HM	-	RECORD AG DRILL	ILIX NORM DIN	140°	TiAIN FUTURA	-	16 ÷ 40	-	-	-	-	-	-	157

► RECORD INDEX DRILL Corpi | Bodies

GTR3D		ACCIAO Steel	≤3xd	RECORD INDEX DRILL	ILIX NORM DIN	-	-		16,0 ÷ 50,0	-	-	-	-	-	-	161
NEW GSQ3D		ACCIAO Steel	≤3xd	RECORD INDEX DRILL	ILIX NORM DIN	-	-		16,0 ÷ 50,0	-	-	-	-	-	-	162
NEW GTR4D		ACCIAO Steel	≤4xd	RECORD INDEX DRILL	ILIX NORM DIN	-	-		16,0 ÷ 50,0	-	-	-	-	-	-	163
NEW GSQ4D		ACCIAO Steel	≤4xd	RECORD INDEX DRILL	ILIX NORM DIN	-	-		16,0 ÷ 50,0	-	-	-	-	-	-	164
DHTR		ACCIAO Steel	≤8xd	RECORD INDEX DRILL	ILIX NORM DIN	-	-		25,0 ÷ 45,0	-	-	-	-	-	-	165

Codice Utensile Tool code		Materiale utensile Tool material	Profondità di taglio Cutting depth	Tipologia Type	DIN	Angolo di testa Point angle	Rivestimento Coating	Codolo Shank	Gamma diametri Diameters range	Tolleranza costruttiva Manufacturing tolerance	P	M	K	N	S	H	Pagina utensile Tool page
-----------------------------	--	-------------------------------------	---------------------------------------	-------------------	-----	--------------------------------	-------------------------	-----------------	-----------------------------------	---	---	---	---	---	---	---	------------------------------

► RECORD INDEX DRILL

Corpi | Bodies

NEW	DHMTR		ACCIAO Steel	≤10xd	RECORD INDEX DRILL	ILIX NORM DIN	-	-	9766	45,0 ÷ 180,0	-	-	-	-	-	-	168
------------	--------------	--	------------------------	-------	--------------------	-------------------------	---	---	------	-----------------	---	---	---	---	---	---	------------

► RECORD INDEX DRILL

Inserti | Inserts

WCEX LC	AGP25		M.D.I. HM	-	RECORD INDEX DRILL	ILIX NORM DIN	-	TiAIN FUTURA	-	-	-	-	-	-	-	-	175
WCEX LC	AGP35		M.D.I. HM	-	RECORD INDEX DRILL	ILIX NORM DIN	-	TiAIN FUTURA	-	-	-	-	-	-	-	-	175
WCEX MC	AGP25		M.D.I. HM	-	RECORD INDEX DRILL	ILIX NORM DIN	-	TiAIN FUTURA	-	-	-	-	-	-	-	-	176
WCEX MC	AGP35		M.D.I. HM	-	RECORD INDEX DRILL	ILIX NORM DIN	-	TiAIN FUTURA	-	-	-	-	-	-	-	-	176
SPKX MC	AGP25		M.D.I. HM	-	RECORD INDEX DRILL	ILIX NORM DIN	-	TiAIN FUTURA	-	-	-	-	-	-	-	-	177
NEW SPKX MC	AGP35		M.D.I. HM	-	RECORD INDEX DRILL	ILIX NORM DIN	-	TiAIN FUTURA	-	-	-	-	-	-	-	-	177
NEW SPHX LN	AGN010		M.D.I. HM	-	RECORD INDEX DRILL	ILIX NORM DIN	-	-	-	-	-	-	-	-	-	-	178
NEW SPKX MC	AGU30		M.D.I. HM	-	RECORD INDEX DRILL	ILIX NORM DIN	-	TIN	-	-	-	-	-	-	-	-	178

► RECORD INDEX DRILL "DHTR - DHMTR"

Cartucce | Cartridges

CI-CE	DHTR		ACCIAO Steel	-	RECORD INDEX DRILL	ILIX NORM DIN	-	-	-	-	-	-	-	-	-	-	166
CI-CE	DHMTR		ACCIAO Steel	-	RECORD INDEX DRILL	ILIX NORM DIN	-	-	-	-	-	-	-	-	-	-	173

**A
02**

Codice Utensile Tool code	Materiale utensile Tool material	Profondità di taglio Cutting depth	Tipologia Type	DIN	Angolo di testa Point angle	Rivestimento Coating	Codolo Shank	Gamma diametri Diameters range	Tolleranza costruttiva Manufacturing tolerance	P	M	K	N	S	H	Pagina utensile Tool page
-----------------------------	-------------------------------------	---------------------------------------	-------------------	-----	--------------------------------	-------------------------	-----------------	-----------------------------------	---	---	---	---	---	---	---	------------------------------

▶ RECORD INDEX DRILL "DHMTR"
 Cartucce | Cartridges

NEW		ACCIAIO Steel	-	RECORD INDEX DRILL	ILIX NORM DIN	-	-	-	-	-	-	-	-	-	-	173
CI-CE																

▶ RECORD INDEX DRILL "DHTR - DHMTR"
 Punta pilota | Pilot Drill

NEW		HSS	-	RECORD INDEX DRILL	ILIX NORM DIN	-	TiN	-	-	-	-	-	-	-	-	166
DHP																171

▶ RECORD INDEX DRILL "DHMTR"
 Attacco base | Shank

NEW		ACCIAIO Steel	-	RECORD INDEX DRILL	ILIX NORM DIN	-	-	-	13,0 ÷ 40,0	-	-	-	-	-	-	169
DHMSH ...																

▶ RECORD INDEX DRILL "DHMTR"
 Estensione | Extension

NEW		ACCIAIO Steel	-	RECORD INDEX DRILL	ILIX NORM DIN	-	-	-	13,0 ÷ 40,0	-	-	-	-	-	-	170
DHMEX ...																

▶ RECORD INDEX DRILL "DHMTR"
 Anello di trascinamento | Drive ring

NEW		ACCIAIO Steel	-	RECORD INDEX DRILL	ILIX NORM DIN	-	-	-	-	-	-	-	-	-	-	171
DHRG...																

▶ RECORD INDEX DRILL "DHMTR"
 Bussola di riduzione | Reducer drill sleeves

NEW		ACCIAIO Steel	-	RECORD INDEX DRILL	ILIX NORM DIN	-	-	-	16,0 ÷ 40,0	-	-	-	-	-	-	172
DHMBS ...																

▶ RECORD INDEX DRILL "DHMTR"
 Riduzioni | Reducers

NEW		ACCIAIO Steel	-	RECORD INDEX DRILL	ILIX NORM DIN	-	-	-	28,0 ÷ 58,0	-	-	-	-	-	-	172
DHMRD ...																

PUNTE A FISSAGGIO MECCANICO
INDEXABLE DRILLS

A
02



A.02.02

Gamma prodotti
Products range



I corpi punta della serie RECORD AG DRILL 500/600 sono progettati per lavorare, con avanzamenti elevati, acciai, acciai inossidabili, ghise e materiali non ferrosi. Disponibili in due tipologie aventi differente sistema di bloccaggio della cuspidi nelle versioni 1xD, 3xD, 5xD, 7xD e 10xD con fori di refrigerazione interna.

The RECORD AG DRILL 500/600 series bodies are designed to machining, with high feed rates, steels, stainless steels, cast irons and non-ferrous materials. Available in two types with different insert clamping systems in 1xD, 3xD, 5xD, 7xD and 10xD versions with internal coolant holes.

Record

CORPI | BODY

AG DRILL



IL DESIGN ESCLUSIVO, PROGETTATO PER RIDURRE LE FORZE DI TAGLIO, GARANTISCE UNA QUALITÀ OTTIMALE DEL FORO.

The specific design, developed to reduce cutting forces, guarantees optimum hole quality.

GLI AMPI VANI ASSICURANO UN'EFFICIENTE EVACUAZIONE DEL TRUCIOLO.

Large chip pockets ensure efficient chip evacuation.

L'ACCURATO ACCOPPIAMENTO TRA SEDE E CUSPIDE ASSICURA NOTEVOLE STABILITÀ AL PROCESSO DI FORATURA.

The accurate coupling between seat and inserts ensures remarkable stability of the drilling process.

SEMPLICE SOSTITUZIONE DELLA CUSPIDE TRAMITE VITE O GRANO SECONDO LA TIPOLOGIA SCELTA.

Simple insert replacement by means of screw or grain according to the type chosen.

MINOR USURA DELLO STELO GRAZIE AL TRATTAMENTO SUPERFICIALE DI NICHELATURA DEPOSITATO CHIMICAMENTE SULL' ACCIAIO.

Less wear on the shank thanks to the nickel surface treatment chemically deposited on the steel.

CODOLO DIN 1835E IN TOLLERANZA h6 GARANTISCE UN SICURO BLOCCAGGIO NEL PORTAUTENSILE.

DIN 1835E shank and tolerance h6 guarantee a safe clamping in the tool holder.

RECORD AG DRILL 500

Corpi a fissaggio meccanico per cuspidi in metallo duro | Indexable bodies for solid carbide inserts

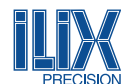

NEW

**ILIX
NORM**
DIN

1×d

1835 E



P. 192

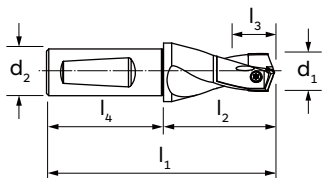

Punta preforo per RECORD AG DRILL 507D - 510D
Pilot drill for RECORD AG DRILL 507D - 510D



ACCIAIO

-



MATERIALE | MATERIAL

RIVESTIMENTO | COATING

DIREZIONE TAGLIO | CUTTING DIRECTION

INSERTI COMPATIBILI (VEDI PAGINA 152÷156)
SUITABLE INSERTS (SEE PAGE 152÷156)



	d ₁ (Gamma - Range)	d ₂	l ₁	l ₂	l ₃	l ₄	501D
--	-----------------------------------	----------------	----------------	----------------	----------------	----------------	-------------

AA	16,00 - 16,40	20	108	58	35	50	●
AB	16,50 - 16,90	20	108	58	35	50	●
AC	17,00 - 17,40	20	108	58	35	50	●
AD	17,50 - 17,90	20	108	58	35	50	●
AE	18,00 - 18,40	20	110	60	37	50	●
AF	18,50 - 18,90	20	110	60	37	50	●
AG	19,00 - 19,40	20	110	60	37	50	●
AH	19,50 - 19,90	20	110	60	37	50	●
AI	20,00 - 20,40	25	119	63	40	56	●
AJ	20,50 - 20,90	25	119	63	40	56	●
AK	21,00 - 21,40	25	119	63	40	56	●
AL	21,50 - 21,90	25	119	63	40	56	●
AM	22,00 - 22,40	25	119	63	40	56	●
AN	22,50 - 22,90	25	119	63	40	56	●
AO	23,00 - 23,40	25	121	65	42	56	●
AP	23,50 - 23,90	25	121	65	42	56	●
AQ	24,00 - 24,40	25	121	65	42	56	●
AR	24,50 - 24,90	25	122	66	43	56	●
AS	25,00 - 25,40	25	122	66	43	56	●
AT	25,50 - 25,90	32	131	71	44	60	●
AU	26,00 - 26,40	32	133	73	46	60	●
AV	26,50 - 26,90	32	133	73	46	60	●
AW	27,00 - 27,40	32	133	73	46	60	●
AX	27,50 - 27,90	32	133	73	46	60	●
AY	28,00 - 28,40	32	135	75	48	60	●
AZ	28,50 - 28,90	32	135	75	48	60	●
BA	29,00 - 29,40	32	135	75	48	60	●

	d ₁ (Gamma - Range)	d ₂	l ₁	l ₂	l ₃	l ₄	501D
--	-----------------------------------	----------------	----------------	----------------	----------------	----------------	-------------

BB	29,50 - 29,90	32	135	75	48	60	●
BC	30,00 - 30,40	32	137	77	50	60	●
BD	30,50 - 30,90	32	137	77	50	60	●
BE	31,00 - 31,40	32	137	77	50	60	●
BF	31,50 - 31,90	32	137	77	50	60	●
BG	32,00 - 32,90	32	137	77	50	60	●

Esempio d'ordine: (501D + AA) | Ordering example: (501D + AA)

Vite inserto e chiave torx include, inserti non inclusi | Insert Screw and torx key included, inserts not included

A
02

NEW

ILIX NORM
DIN

$\leq 3 \times d$

1835 E

A

P. 192

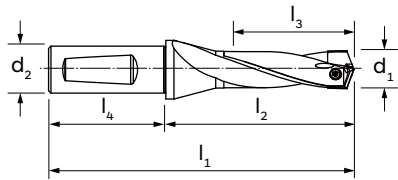

ACCIAIO
-
↻

MATERIALE | MATERIAL

RIVESTIMENTO | COATING

DIREZIONE TAGLIO | CUTTING DIRECTION

INSERTI COMPATIBILI (VEDI PAGINA 152+156)
SUITABLE INSERTS (SEE PAGE 152+156)



	d_1 (Gamma - Range)	d_2	l_1	l_2	l_3	l_4	503D
--	--------------------------	-------	-------	-------	-------	-------	------

	d_1 (Gamma - Range)	d_2	l_1	l_2	l_3	l_4	503D
--	--------------------------	-------	-------	-------	-------	-------	------

A	12,00 - 12,40	16	111	63	42	48	●
B	12,50 - 12,90	16	111	63	42	48	●
C	13,00 - 13,40	16	111	63	42	48	●
D	13,50 - 13,90	16	111	63	42	48	●
E	14,00 - 14,40	20	122	72	48	50	●
F	14,50 - 14,90	20	122	72	48	50	●
G	15,00 - 15,40	20	122	72	48	50	●
H	15,50 - 15,90	20	122	72	48	50	●
AA	16,00 - 16,40	20	130	80	54	50	●
AB	16,50 - 16,90	20	130	80	54	50	●
AC	17,00 - 17,40	20	130	80	54	50	●
AD	17,50 - 17,90	20	130	80	54	50	●
AE	18,00 - 18,40	20	138	88	60	50	●
AF	18,50 - 18,90	20	138	88	60	50	●
AG	19,00 - 19,40	20	138	88	60	50	●
AH	19,50 - 19,90	20	138	88	60	50	●
AI	20,00 - 20,40	25	153	97	66	56	●
AJ	20,50 - 20,90	25	153	97	66	56	●
AK	21,00 - 21,40	25	153	97	66	56	●
AL	21,50 - 21,90	25	153	97	66	56	●
AM	22,00 - 22,40	25	153	97	66	56	●
AN	22,50 - 22,90	25	153	97	66	56	●
AO	23,00 - 23,40	25	160	104	72	56	●
AP	23,50 - 23,90	25	160	104	72	56	●
AQ	24,00 - 24,40	25	160	104	72	56	●
AR	24,50 - 24,90	25	170	114	78	56	●
AS	25,00 - 25,40	25	170	114	78	56	●

AT	25,50 - 25,90	32	170	114	78	60	●
AU	26,00 - 26,40	32	182	122	84	60	●
AV	26,50 - 26,90	32	182	122	84	60	●
AW	27,00 - 27,40	32	182	122	84	60	●
AX	27,50 - 27,90	32	182	122	84	60	●
AY	28,00 - 28,40	32	190	130	90	60	●
AZ	28,50 - 28,90	32	190	130	90	60	●
BA	29,00 - 29,40	32	190	130	90	60	●
BB	29,50 - 29,90	32	190	130	90	60	●
BC	30,00 - 30,40	32	198	138	96	60	●
BD	30,50 - 30,90	32	198	138	96	60	●
BE	31,00 - 31,40	32	198	138	96	60	●
BF	31,50 - 31,90	32	198	138	96	60	●
BG	32,00 - 32,90	32	198	138	96	60	●
BH	33,00 - 33,90	32	207	147	105	60	●
BI	34,00 - 34,90	32	207	147	105	60	●
BJ	35,00 - 35,90	32	212	152	110	60	●
BK	36,00 - 36,90	32	212	152	110	60	●
BL	37,00 - 37,90	32	222	162	120	60	●
BM	38,00 - 38,90	32	222	162	120	60	●
BN	39,00 - 40,00	32	222	162	120	60	●

Esempio d'ordine: (503D + A) | **Ordering example:** (503D + A) ● Nuovi diametri | New diameters
Vite inserto e chiave torx include, inserti non inclusi | **Insert Screw and torx key included, inserts not included**

RECORD AG DRILL 500

Corpi a fissaggio meccanico per cuspidi in metallo duro | Indexable bodies for solid carbide inserts



NEW

ILIX NORM
DIN

$\leq 5 \times d$

1835 E

A

P. 192

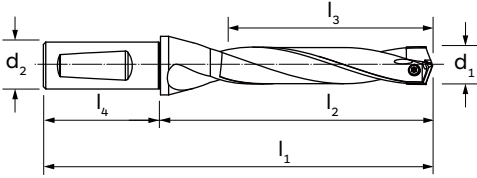

**A
02**

MATERIALE | MATERIAL

RIVESTIMENTO | COATING

DIREZIONE TAGLIO | CUTTING DIRECTION

ACCIAIO

-

↻

INSERTI COMPATIBILI (VEDI PAGINA 152÷156)
SUITABLE INSERTS (SEE PAGE 152÷156)



	d_1 (Gamma - Range)	d_2	l_1	l_2	l_3	l_4	505D
--	--------------------------	-------	-------	-------	-------	-------	-------------

A	12,00 - 12,40	16	139	91	70	48	●
B	12,50 - 12,90	16	139	91	70	48	●
C	13,00 - 13,40	16	139	91	70	48	●
D	13,50 - 13,90	16	139	91	70	48	●
E	14,00 - 14,40	20	154	104	80	50	●
F	14,50 - 14,90	20	154	104	80	50	●
G	15,00 - 15,40	20	154	104	80	50	●
H	15,50 - 15,90	20	154	104	80	50	●
AA	16,00 - 16,40	20	166	116	90	50	●
AB	16,50 - 16,90	20	166	116	90	50	●
AC	17,00 - 17,40	20	166	116	90	50	●
AD	17,50 - 17,90	20	166	116	90	50	●
AE	18,00 - 18,40	20	178	128	100	50	●
AF	18,50 - 18,90	20	178	128	100	50	●
AG	19,00 - 19,40	20	178	128	100	50	●
AH	19,50 - 19,90	20	178	128	100	50	●
AI	20,00 - 20,40	25	197	141	110	56	●
AJ	20,50 - 20,90	25	197	141	110	56	●
AK	21,00 - 21,40	25	197	141	110	56	●
AL	21,50 - 21,90	25	197	141	110	56	●
AM	22,00 - 22,40	25	197	141	110	56	●
AN	22,50 - 22,90	25	197	141	110	56	●
AO	23,00 - 23,40	25	209	153	120	56	●
AP	23,50 - 23,90	25	209	153	120	56	●
AQ	24,00 - 24,40	25	209	153	120	56	●
AR	24,50 - 24,90	25	222	166	130	56	●
AS	25,00 - 25,40	25	222	166	130	56	●

	d_1 (Gamma - Range)	d_2	l_1	l_2	l_3	l_4	505D
--	--------------------------	-------	-------	-------	-------	-------	-------------

AT	25,50 - 25,90	32	222	166	130	60	●
AU	26,00 - 26,40	32	238	178	140	60	●
AV	26,50 - 26,90	32	238	178	140	60	●
AW	27,00 - 27,40	32	238	178	140	60	●
AX	27,50 - 27,90	32	238	178	140	60	●
AY	28,00 - 28,40	32	250	190	150	60	●
AZ	28,50 - 28,90	32	250	190	150	60	●
BA	29,00 - 29,40	32	250	190	150	60	●
BB	29,50 - 29,90	32	250	190	150	60	●
BC	30,00 - 30,40	32	262	202	160	60	●
BD	30,50 - 30,90	32	262	202	160	60	●
BE	31,00 - 31,40	32	262	202	160	60	●
BF	31,50 - 31,90	32	262	202	160	60	●
● BG	32,00 - 32,90	32	262	202	160	60	●
● BH	33,00 - 33,90	32	277	217	175	60	●
● BI	34,00 - 34,90	32	277	217	175	60	●
● BJ	35,00 - 35,90	32	287	227	185	60	●
● BK	36,00 - 36,90	32	287	227	185	60	●
● BL	37,00 - 37,90	32	302	242	200	60	●
● BM	38,00 - 38,90	32	302	242	200	60	●
● BN	39,00 - 40,00	32	302	242	200	60	●

Esempio d'ordine: (505D + A) | Ordering example: (505D + A) ● Nuovi diametri | New diameters
Vite inserto e chiave torx include, inserti non inclusi | Insert Screw and torx key included, inserts not included

A
02

**ILIX
NORM**

DIN

≤7×d

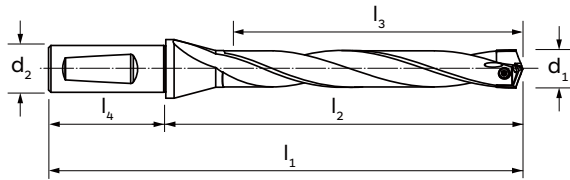

Eeguire foro pilota con art. 501D (vedi pagina 143)
Drill pilot hole with art. 501D (see page 143)



ACCIAIO

-



MATERIALE | MATERIAL

RIVESTIMENTO | COATING

DIREZIONE TAGLIO | CUTTING DIRECTION

INSERTI COMPATIBILI (VEDI PAGINA 152÷156)
SUITABLE INSERTS (SEE PAGE 152÷156)



	d ₁ (Gamma - Range)	d ₂	l ₁	l ₂	l ₃	l ₄	507D
--	-----------------------------------	----------------	----------------	----------------	----------------	----------------	------

A	12,00 - 12,40	16	167	119	98	48	●
B	12,50 - 12,90	16	167	119	98	48	●
C	13,00 - 13,40	16	167	119	98	48	●
D	13,50 - 13,90	16	167	119	98	48	●
E	14,00 - 14,40	20	186	136	112	50	●
F	14,50 - 14,90	20	186	136	112	50	●
G	15,00 - 15,40	20	186	136	112	50	●
H	15,50 - 15,90	20	186	136	112	50	●
AA	16,00 - 16,40	20	202	152	126	50	●
AB	16,50 - 16,90	20	202	152	126	50	●
AC	17,00 - 17,40	20	202	152	126	50	●
AD	17,50 - 17,90	20	202	152	126	50	●
AE	18,00 - 18,40	20	218	168	140	50	●
AF	18,50 - 18,90	20	218	168	140	50	●
AG	19,00 - 19,40	20	218	168	140	50	●
AH	19,50 - 19,90	20	218	168	140	50	●
AI	20,00 - 20,40	25	241	185	154	56	●
AJ	20,50 - 20,90	25	241	185	154	56	●
AK	21,00 - 21,40	25	241	185	154	56	●
AL	21,50 - 21,90	25	241	185	154	56	●
AM	22,00 - 22,40	25	241	185	154	56	●
AN	22,50 - 22,90	25	241	185	154	56	●
AO	23,00 - 23,40	25	257	201	168	56	●
AP	23,50 - 23,90	25	257	201	168	56	●
AQ	24,00 - 24,40	25	257	201	168	56	●
AR	24,50 - 24,90	25	274	218	182	56	●
AS	25,00 - 25,40	25	274	218	182	56	●

	d ₁ (Gamma - Range)	d ₂	l ₁	l ₂	l ₃	l ₄	507D
--	-----------------------------------	----------------	----------------	----------------	----------------	----------------	------

AT	25,50 - 25,90	32	274	218	182	60	●
AU	26,00 - 26,40	32	294	234	196	60	●
AV	26,50 - 26,90	32	294	234	196	60	●
AW	27,00 - 27,40	32	294	234	196	60	●
AX	27,50 - 27,90	32	294	234	196	60	●
AY	28,00 - 28,40	32	310	250	210	60	●
AZ	28,50 - 28,90	32	310	250	210	60	●
BA	29,00 - 29,40	32	310	250	210	60	●
BB	29,50 - 29,90	32	310	250	210	60	●
BC	30,00 - 30,40	32	326	266	224	60	●
BD	30,50 - 30,90	32	326	266	224	60	●
BE	31,00 - 31,40	32	326	266	224	60	●
BF	31,50 - 31,90	32	326	266	224	60	●
BG	32,00 - 32,90	32	326	266	224	60	●

Esempio d'ordine: (507D + A) | Ordering example: (507D + A)

Vite inserto e chiave torx include, inserti non inclusi | Insert Screw and torx key included, inserts not included

RECORD AG DRILL 500

Corpi a fissaggio meccanico per cuspidi in metallo duro | Indexable bodies for solid carbide inserts



NEW **ILIX NORM** $\leq 10 \times d$ **1835 E** **A** **P. 194**
DIN

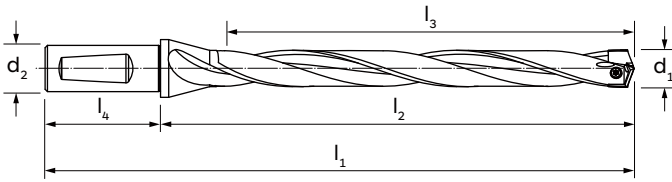

Eseguire foro pilota con art. 501D (vedi pagina 143)
 Drill pilot hole with art. 501D (see page 143)



ACCIAIO



MATERIALE | MATERIAL

RIVESTIMENTO | COATING

DIREZIONE TAGLIO | CUTTING DIRECTION

INSERTI COMPATIBILI (VEDI PAGINA 152+156)
 SUITABLE INSERTS (SEE PAGE 152+156)



	d_1 (Gamma - Range)	d_2 (h6)	l_1	l_2	l_3	l_4	510D
--	--------------------------	---------------	-------	-------	-------	-------	------

	d_1 (Gamma - Range)	d_2 (h6)	l_1	l_2	l_3	l_4	510D
--	--------------------------	---------------	-------	-------	-------	-------	------

AA	16,00 - 16,40	20	243	195	168	50	●
AB	16,50 - 16,90	20	249	201	170	50	●
AC	17,00 - 17,40	20	255	207	178	50	●
AD	17,50 - 17,90	20	260	212	184	50	●
AE	18,00 - 18,40	20	267	219	188	50	●
AF	18,50 - 18,90	20	274	224	194	50	●
AG	19,00 - 19,40	20	280	230	199	50	●
AH	19,50 - 19,90	20	286	236	204	50	●
AI	20,00 - 20,40	25	292	242	209	56	●
AJ	20,50 - 20,90	25	306	250	214	56	●
AK	21,00 - 21,40	25	312	256	219	56	●
AL	21,50 - 21,90	25	317	261	224	56	●
AM	22,00 - 22,40	25	323	267	229	56	●
AN	22,50 - 22,90	25	329	273	234	56	●
AO	23,00 - 23,40	25	335	279	240	56	●
AP	23,50 - 23,90	25	341	285	245	56	●
AQ	24,00 - 24,40	25	347	291	250	56	●
AR	24,50 - 24,90	25	352	296	255	56	●
AS	25,00 - 25,40	25	359	303	260	56	●
AT	25,50 - 25,90	32	369	309	265	60	●
AU	26,00 - 26,40	32	377	317	270	60	●
AV	26,50 - 26,90	32	382	322	275	60	●
AW	27,00 - 27,40	32	388	328	280	60	●
AX	27,50 - 27,90	32	394	334	285	60	●
AY	28,00 - 28,40	32	400	340	290	60	●
AZ	28,50 - 28,90	32	405	345	295	60	●
BA	29,00 - 29,40	32	412	352	301	60	●

BB	29,50 - 29,90	32	418	358	306	60	●
BC	30,00 - 30,40	32	424	364	311	60	●
BD	30,50 - 30,90	32	429	369	316	60	●
BE	31,00 - 31,40	32	435	375	321	60	●
BF	31,50 - 31,90	32	441	381	326	60	●
BG	32,00 - 32,90	32	451	391	336	60	●

Esempio d'ordine: (510D + AA) | Ordering example: (510D + AA)
 Vite inserto e chiave torx include, inserti non inclusi | Insert Screw and torx key included, inserts not included

A
02

**ILIX
NORM**

DIN

≤3xd



1835 E



P. 196

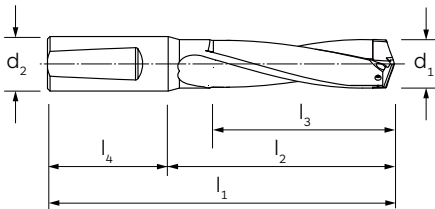

ACCIAIO

-



MATERIALE | MATERIAL

RIVESTIMENTO | COATING

DIREZIONE TAGLIO | CUTTING DIRECTION

INSERTI COMPATIBILI (VEDI PAGINA 157-158)

SUITABLE INSERTS (SEE PAGE 157-158)

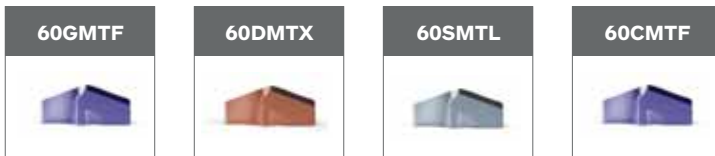

	d ₁ (Gamma - Range)	d ₂	l ₁	l ₂	l ₃	l ₄	603D
--	-----------------------------------	----------------	----------------	----------------	----------------	----------------	------

	d ₁ (Gamma - Range)	d ₂	l ₁	l ₂	l ₃	l ₄	603D
--	-----------------------------------	----------------	----------------	----------------	----------------	----------------	------

A	16,00 - 17,00	20	130	76	54	50	●
B	17,10 - 17,90	20	130	76	54	50	●
C	18,00 - 19,00	20	138	84	60	50	●
D	19,10 - 20,00	20	138	84	60	50	●
E	20,10 - 21,00	25	153	93	66	56	●
F	21,10 - 22,50	25	153	93	66	56	●
G	22,60 - 24,00	25	161	101	72	56	●
H	24,10 - 25,50	25	170	110	78	56	●
I	25,60 - 27,50	32	182	118	84	60	●
L	27,60 - 29,50	32	190	126	90	60	●
M	29,60 - 32,00	32	198	134	96	60	■
N	32,10 - 34,50	32	206	142	102	60	■
O	34,60 - 37,50	32	218	154	114	60	■
P	37,60 - 40,00	32	231	167	120	60	■

Esempio d'ordine: (603D + A) | Ordering example: (603D + A)

Vite inserto e chiave torx incluse, inserti non inclusi | Insert Screw and torx key included, inserts not included

■ Fino ad esaurimento scorte | Till stocks last

RECORD AG DRILL 600

Corpi a fissaggio meccanico per cuspidi in metallo duro | Indexable bodies for solid carbide inserts



**ILIX
NORM**

DIN

≤5Xd

1835 E



P. 196

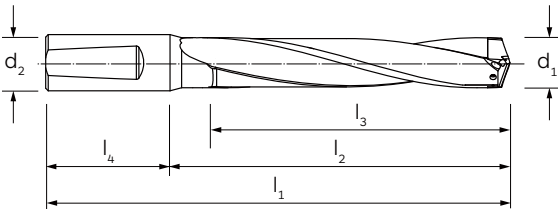

**A
02**

MATERIALE | MATERIAL

RIVESTIMENTO | COATING

DIREZIONE TAGLIO | CUTTING DIRECTION

ACCIAIO

-

↻

INSERTI COMPATIBILI (VEDI PAGINA 157-158)
SUITABLE INSERTS (SEE PAGE 157-158)

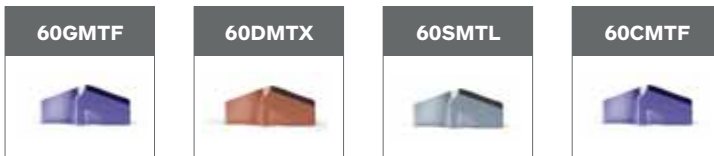

	d ₁ (Gamma - Range)	d ₂	l ₁	l ₂	l ₃	l ₄	605D
--	-----------------------------------	----------------	----------------	----------------	----------------	----------------	------

	d ₁ (Gamma - Range)	d ₂	l ₁	l ₂	l ₃	l ₄	605D
--	-----------------------------------	----------------	----------------	----------------	----------------	----------------	------

A	16,00 - 17,00	20	166	112	90	50	●
B	17,10 - 17,90	20	166	112	90	50	●
C	18,00 - 19,00	20	178	124	100	50	●
D	19,10 - 20,00	20	178	124	100	50	●
E	20,10 - 21,00	25	197	137	110	56	●
F	21,10 - 22,50	25	197	137	110	56	●
G	22,60 - 24,00	25	209	149	120	56	●
H	24,10 - 25,50	25	222	162	130	56	●
I	25,60 - 27,50	32	238	174	140	60	●
L	27,60 - 29,50	32	250	186	150	60	●
M	29,60 - 32,00	32	262	198	160	60	■
N	32,10 - 34,50	32	274	210	170	60	■
O	34,60 - 37,50	32	292	228	190	60	■
P	37,60 - 40,00	32	311	247	200	60	■

Esempio d'ordine: (605D + A) | Ordering example: (605D + A)

Vite inserto e chiave torx incluse, inserti non inclusi | Insert Screw and torx key included, inserts not included

■ Fino ad esaurimento scorte | Till stocks last

A
02



**ILIX
NORM**

DIN

≤7×d



1835 E



A



P. 196

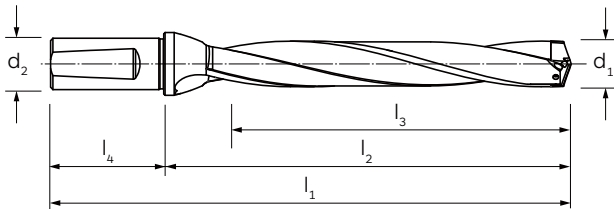

ACCIAIO

-



MATERIALE | MATERIAL

RIVESTIMENTO | COATING

DIREZIONE TAGLIO | CUTTING DIRECTION

INSERTI COMPATIBILI (VEDI PAGINA 157-158)

SUITABLE INSERTS (SEE PAGE 157-158)



	d ₁ (Gamma - Range)	d ₂	l ₁	l ₂	l ₃	l ₄	607D
--	-----------------------------------	----------------	----------------	----------------	----------------	----------------	------

A	16,00 - 17,00	20	202	148	126	50	●
B	17,10 - 17,90	20	202	148	126	50	●
C	18,00 - 19,00	20	218	164	140	50	●
D	19,10 - 20,00	20	218	164	140	50	●
E	20,10 - 21,00	25	241	181	154	56	●
F	21,10 - 22,50	25	241	181	154	56	●
G	22,60 - 24,00	25	257	197	168	56	●
H	24,10 - 25,50	25	274	214	182	56	●
I	25,60 - 27,50	32	294	230	196	60	●
L	27,60 - 29,50	32	310	246	210	60	●
M	29,60 - 32,00	32	326	262	224	60	■
N	32,10 - 34,50	32	342	278	238	60	■
O	34,60 - 37,50	32	366	302	266	60	■
P	37,60 - 40,00	32	391	327	280	60	■

	d ₁ (Gamma - Range)	d ₂ (h6)	l ₁	l ₂	l ₃	l ₄	607D
--	-----------------------------------	------------------------	----------------	----------------	----------------	----------------	------

Esempio d'ordine: (607D + A) | Ordering example: (607D + A)

Vite inserto e chiave torx incluse, inserti non inclusi | Insert Screw and torx key included, inserts not included

■ Fino ad esaurimento scorte | Till stocks last

Le affilature ed i rivestimenti delle cuspidi della serie RECORD AG DRILL 500/600 sono studiati per affrontare una vasta gamma di materiali ferrosi e non ferrosi, a truciolo lungo e corto, con una soluzione geometrica autocentrante per migliorare le prestazioni in tutte le applicazioni. Disponibili nei diametri da 16 a 40 mm per entrambe le tipologie.

Inserts geometries and coatings of the RECORD AG DRILL 500/600 series are designed for a wide range of ferrous and non-ferrous materials, long and short chips, with a self-centring geometric solution to improve performance in all applications. Available in diameters from 16 to 40 mm for both types.

A
02



Record

AG DRILL

INSERTI | INSERTS

50...



60...



PH (TF)

CUSPIDE UNIVERSALE SVILUPPATA PER L'ESECUZIONE DI FORI PILOTA.
Universal insert developed for drilling pilot holes.

CM (TF)

CUSPIDE IDONEA PER LE LAVORAZIONI DI GHISE.
Insert suitable for cast iron machining.

GM (TF)

CUSPIDE IDONEA PER LE LAVORAZIONI DI ACCIAI E GHISE.
Insert suitable for machining steels and cast irons.

DM (TX)

CUSPIDE IDONEA PER LE LAVORAZIONI DI ACCIAI INOSSIDABILI.
Insert suitable for stainless steel machining.

SM (TL)

CUSPIDE IDONEA PER LE LAVORAZIONI DI MATERIALI NON FERROSI.
Insert suitable for machining non-ferrous materials.

A
02

NEW

**ILIX
NORM**
DIN

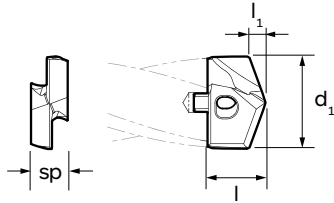

Per l'esecuzione di fori pilota
For drilling pilot holes



MATERIALE | MATERIAL

RIVESTIMENTO | COATING

DIREZIONE TAGLIO | CUTTING DIRECTION

M.D.I.-HM

TiAlN
Futura



GRUPPO MATERIALI
MATERIAL GROUPS

P | Acciai | Steels

M | Acciai Inossidabili | Stainless Steels

K | Ghise | Cast Irons

N | Metalli non ferrosi | Non-ferrous metals

S | Leghe resistenti al calore e Titanio | HRSA and Titanium

H | Acciai Temprati | Hardened Steels

P

M

K

N

S

H

	d ₁ (m7)	l	l ₁	sp	Vite Screw	Chiave Torx Torx key	50 PHTF
AA	16,0	10,6	2,6	7,0	VTF 3.5X.6	KY T10	●
AB	16,5	10,6	2,7	7,0	VTF 3.5X.6	KY T10	●
AC	17,0	10,6	2,7	7,0	VTF 3.5X.6	KY T10	●
AD	17,5	10,6	2,8	7,0	VTF 3.5X.6	KY T10	●
AD	17,6	10,6	2,8	7,0	VTF 3.5X.6	KY T10	●
AE	18,0	12,1	2,9	8,0	VTE 4X.7	KY T15	●
AF	18,5	12,1	3,0	8,0	VTE 4X.7	KY T15	●
AG	19,0	12,1	3,0	8,0	VTE 4X.7	KY T15	●
AH	19,5	12,1	3,1	8,0	VTE 4X.7	KY T15	●
AH	19,6	12,1	3,1	8,0	VTE 4X.7	KY T15	●
AI	20,0	13,3	3,2	9,0	VTG 4.5X.75	KY T15	●
AJ	20,5	13,3	3,3	9,0	VTG 4.5X.75	KY T15	●
AK	21,0	13,3	3,4	9,0	VTG 4.5X.75	KY T15	●
AK	21,1	13,3	3,4	9,0	VTG 4.5X.75	KY T15	●
AL	21,5	13,3	3,4	9,0	VTG 4.5X.75	KY T15	●
AM	22,0	14,8	3,5	10,0	VTH 5X.8X19.75	KY T20	●
AN	22,5	14,8	3,6	10,0	VTH 5X.8X19.75	KY T20	●
AO	23,0	14,8	3,7	10,0	VTH 5X.8X19.75	KY T20	●
AP	23,5	14,8	3,8	10,0	VTH 5X.8X19.75	KY T20	●
AQ	24,0	15,3	3,8	11,0	VTH 5X.8X19.75	KY T20	●
AQ	24,1	15,3	3,8	11,0	VTH 5X.8X19.75	KY T20	●
AR	24,5	15,3	3,9	11,0	VTH 5X.8X19.75	KY T20	●
AS	25,0	15,3	4,0	11,0	VTH 5X.8X19.75	KY T20	●
AT	25,5	15,3	4,1	11,0	VTH 5X.8X19.75	KY T20	●
AT	25,7	15,3	4,1	11,0	VTH 5X.8X19.75	KY T20	●
AU	26,0	19,4	4,1	12,0	VTH 5X.8X19.75	KY T20	●
AV	26,5	19,4	4,2	12,0	VTH 5X.8X19.75	KY T20	●

Esempio d'ordine: (50PHTF + 16) | Ordering example: (50PHTF + 16)
Chiave torx non inclusa | Torx key not included

01/02 →

RECORD AG DRILL 500

Inseri in metallo duro integrale per punte a fissaggio meccanico | Solid carbide inserts for indexable drills



	d ₁ (m7)	l	l ₁	sp	Vite Screw	Chiave Torx Torx key	50 PHTF
AW	27,0	19,4	4,3	12,0	VTH 5X.8X19.75	KY T20	●
AX	27,5	19,4	4,4	12,0	VTH 5X.8X19.75	KY T20	●
AX	27,7	19,4	4,4	12,0	VTH 5X.8X19.75	KY T20	●
AY	28,0	20,1	4,5	13,0	VTH 5X.8X19.75	KY T20	●
AZ	28,5	20,1	4,5	13,0	VTH 5X.8X19.75	KY T20	●
BA	29,0	20,1	4,6	13,0	VTH 5X.8X19.75	KY T20	●
BB	29,5	20,1	4,7	13,0	VTH 5X.8X19.75	KY T20	●
BC	30,0	21,7	4,8	14,0	VTI 6X1X27	KY T25	●
BD	30,5	21,7	4,9	14,0	VTI 6X1X27	KY T25	●
BE	31,0	21,7	4,9	14,0	VTI 6X1X27	KY T25	●
BF	31,5	21,7	5,0	14,0	VTI 6X1X27	KY T25	●
BG	32,0	22,4	5,1	15,0	VTI 6X1X28.5	KY T25	●

02/02

Esempio d'ordine: (50PHTF + 27) | Ordering example: (50PHTF + 27)

Chiave torx non inclusa | Torx key not included



A
02

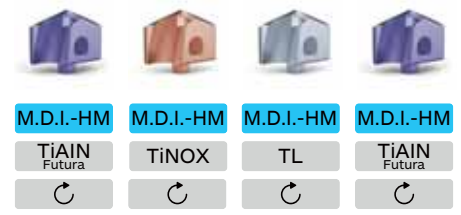
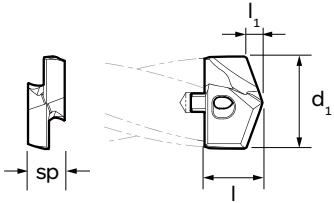

M.D.I.-HM	M.D.I.-HM	M.D.I.-HM	M.D.I.-HM
TiAIN Futura	TiNOX	TL	TiAIN Futura
↻	↻	↻	↻
P	-	-	-
-	M	-	-
-	-	-	K
-	-	N	-
-	S	-	-
-	-	-	-

MATERIALE MATERIAL
RIVESTIMENTO COATING
DIREZIONE TAGLIO CUTTING DIRECTION
P Acciai Steels
M Acciai Inossidabili Stainless Steels
K Ghise Cast Irons
N Metalli non ferrosi Non-ferrous metals
S Leghe resistenti al calore e Titanio HRSA and Titanium
H Acciai Temprati Hardened Steels

	d ₁ (h7)	l	l ₁	sp	Vite Screw	Chiave Torx Torx key	50 GMTF	50 DMTX	50 SMTL	50 CMTF
A	12,0	7,8	2,2	5,0	VTA 2.2X.45	KY T7	●	●	●	●
A	12,1	7,8	2,2	5,0	VTA 2.2X.45	KY T7	●	●	●	●
A	12,2	7,8	2,2	5,0	VTA 2.2X.45	KY T7	●	●	●	●
A	12,3	7,8	2,2	5,0	VTA 2.2X.45	KY T7	●	●	●	●
A	12,4	7,8	2,2	5,0	VTA 2.2X.45	KY T7	●	●	●	●
B	12,5	7,8	2,3	5,0	VTA 2.2X.45	KY T7	●	●	●	●
B	12,6	7,8	2,3	5,0	VTA 2.2X.45	KY T7	●	●	●	●
B	12,7	7,8	2,3	5,0	VTA 2.2X.45	KY T7	●	●	●	●
B	12,8	7,8	2,3	5,0	VTA 2.2X.45	KY T7	●	●	●	●
B	12,9	7,8	2,3	5,0	VTA 2.2X.45	KY T7	●	●	●	●
C	13,0	8,6	2,4	5,5	VTB 2.5X.45	KY T8	●	●	●	●
C	13,1	8,6	2,4	5,5	VTB 2.5X.45	KY T8	●	●	●	●
C	13,2	8,6	2,4	5,5	VTB 2.5X.45	KY T8	●	●	●	●
C	13,3	8,6	2,4	5,5	VTB 2.5X.45	KY T8	●	●	●	●
C	13,4	8,6	2,4	5,5	VTB 2.5X.45	KY T8	●	●	●	●
D	13,5	8,6	2,4	5,5	VTB 2.5X.45	KY T8	●	●	●	●
D	13,6	8,6	2,4	5,5	VTB 2.5X.45	KY T8	●	●	●	●
D	13,7	8,6	2,4	5,5	VTB 2.5X.45	KY T8	●	●	●	●
D	13,8	8,6	2,5	5,5	VTB 2.5X.45	KY T8	●	●	●	●
D	13,9	8,6	2,5	5,5	VTB 2.5X.45	KY T8	●	●	●	●
E	14,0	9,7	2,5	6,0	VTC 3X.5	KY T9	●	●	●	●
E	14,1	9,7	2,5	6,0	VTC 3X.5	KY T9	●	●	●	●
E	14,2	9,7	2,5	6,0	VTC 3X.5	KY T9	●	●	●	●
E	14,3	9,7	2,6	6,0	VTC 3X.5	KY T9	●	●	●	●
E	14,4	9,7	2,6	6,0	VTC 3X.5	KY T9	●	●	●	●
F	14,5	9,7	2,6	6,0	VTC 3X.5	KY T9	●	●	●	●
F	14,6	9,7	2,7	6,0	VTC 3X.5	KY T9	●	●	●	●

Esempio d'ordine: (50GMTF + 12) | Ordering example: (50GMTF + 12)
 Chiave torx non inclusa | Torx key not included

01/03 →

RECORD AG DRILL 500

Inseri in metallo duro integrale per punte a fissaggio meccanico | Solid carbide inserts for indexable drills

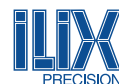

A
02



	d ₁ (h7)	l	l ₁	sp	Vite Screw	Chiave Torx Torx key	50 GMTF	50 DMTX	50 SMTL	50 CMTF
F	14,7	9,7	2,7	6,0	VTC 3X.5	KY T9	●	●	●	●
F	14,8	9,7	2,7	6,0	VTC 3X.5	KY T9	●	●	●	●
F	14,9	9,7	2,7	6,0	VTC 3X.5	KY T9	●	●	●	●
G	15,0	9,9	2,7	6,0	VTD 3X.5	KY T10	●	●	●	●
G	15,1	9,9	2,7	6,0	VTD 3X.5	KY T10	●	●	●	●
G	15,2	9,9	2,8	6,0	VTD 3X.5	KY T10	●	●	●	●
G	15,3	9,9	2,8	6,0	VTD 3X.5	KY T10	●	●	●	●
G	15,4	9,9	2,8	6,0	VTD 3X.5	KY T10	●	●	●	●
H	15,5	9,9	2,8	6,0	VTD 3X.5	KY T10	●	●	●	●
H	15,6	9,9	2,8	6,0	VTD 3X.5	KY T10	●	●	●	●
H	15,7	9,9	2,9	6,0	VTD 3X.5	KY T10	●	●	●	●
H	15,8	9,9	2,9	6,0	VTD 3X.5	KY T10	●	●	●	●
H	15,9	9,9	2,9	6,0	VTD 3X.5	KY T10	●	●	●	●
AA	16,0	11,1	3,1	7,0	VTF 3.5X.6	KY T10	●	●	●	●
AA	16,1	11,1	3,1	7,0	VTF 3.5X.6	KY T10	●	●	●	●
AA	◆ 16,15	11,1	3,1	7,0	VTF 3.5X.6	KY T10	●	●	●	●
AA	16,2	11,1	3,1	7,0	VTF 3.5X.6	KY T10	●	●	●	●
AA	16,3	11,1	3,1	7,0	VTF 3.5X.6	KY T10	●	●	●	●
AA	16,4	11,1	3,1	7,0	VTF 3.5X.6	KY T10	●	●	●	●
AB	16,5	11,1	3,2	7,0	VTF 3.5X.6	KY T10	●	●	●	●
AB	16,6	11,1	3,2	7,0	VTF 3.5X.6	KY T10	●	●	●	●
AB	16,7	11,1	3,2	7,0	VTF 3.5X.6	KY T10	●	●	●	●
AB	◆ 16,75	11,1	3,2	7,0	VTF 3.5X.6	KY T10	●	●	●	●
AB	16,8	11,1	3,2	7,0	VTF 3.5X.6	KY T10	●	●	●	●
AB	16,9	11,1	3,2	7,0	VTF 3.5X.6	KY T10	●	●	●	●
AC	17,0	11,1	3,2	7,0	VTF 3.5X.6	KY T10	●	●	●	●
AC	17,1	11,1	3,3	7,0	VTF 3.5X.6	KY T10	●	●	●	●
AC	17,2	11,1	3,3	7,0	VTF 3.5X.6	KY T10	●	●	●	●
AC	17,3	11,1	3,3	7,0	VTF 3.5X.6	KY T10	●	●	●	●
AC	17,4	11,1	3,3	7,0	VTF 3.5X.6	KY T10	●	●	●	●
AD	17,5	11,1	3,3	7,0	VTF 3.5X.6	KY T10	●	●	●	●
AD	17,6	11,1	3,3	7,0	VTF 3.5X.6	KY T10	●	●	●	●
AD	17,7	11,1	3,3	7,0	VTF 3.5X.6	KY T10	●	●	●	●
AD	17,8	11,1	3,3	7,0	VTF 3.5X.6	KY T10	●	●	●	●
AD	17,9	11,1	3,3	7,0	VTF 3.5X.6	KY T10	●	●	●	●
AE	18,0	12,7	3,4	8,0	VTE 4X.7	KY T15	●	●	●	●
AE	18,1	12,7	3,4	8,0	VTE 4X.7	KY T15	●	●	●	●
AE	18,2	12,7	3,4	8,0	VTE 4X.7	KY T15	●	●	●	●
AE	◆ 18,3	12,7	3,4	8,0	VTE 4X.7	KY T15	●	●	●	●
AE	18,4	12,7	3,4	8,0	VTE 4X.7	KY T15	●	●	●	●
AF	18,5	12,7	3,4	8,0	VTE 4X.7	KY T15	●	●	●	●
AF	18,6	12,7	3,4	8,0	VTE 4X.7	KY T15	●	●	●	●
AF	18,7	12,7	3,4	8,0	VTE 4X.7	KY T15	●	●	●	●
AF	18,8	12,7	3,4	8,0	VTE 4X.7	KY T15	●	●	●	●
AF	18,9	12,7	3,4	8,0	VTE 4X.7	KY T15	●	●	●	●
AG	19,0	12,7	3,5	8,0	VTE 4X.7	KY T15	●	●	●	●
AG	19,1	12,7	3,5	8,0	VTE 4X.7	KY T15	●	●	●	●
AG	19,2	12,7	3,5	8,0	VTE 4X.7	KY T15	●	●	●	●
AG	◆ 19,25	12,7	3,5	8,0	VTE 4X.7	KY T15	●	●	●	●
AG	19,3	12,7	3,5	8,0	VTE 4X.7	KY T15	●	●	●	●
AG	19,4	12,7	3,5	8,0	VTE 4X.7	KY T15	●	●	●	●
AH	19,5	12,7	3,5	8,0	VTE 4X.7	KY T15	●	●	●	●
AH	19,6	12,7	3,5	8,0	VTE 4X.7	KY T15	●	●	●	●
AH	19,7	12,7	3,5	8,0	VTE 4X.7	KY T20	●	●	●	●
AH	19,8	12,7	3,5	8,0	VTE 4X.7	KY T20	●	●	●	●
AH	19,9	12,7	3,5	8,0	VTE 4X.7	KY T20	●	●	●	●

02/03 →

Esempio d'ordine: (50GMTF + 16) | Ordering example: (50GMTF + 16) ◆ Diametri per piastre tubiere | Diameters for tube sheets
Chiave torx non inclusa | Torx key not included

**A
02**

	d ₁ (h7)	l	l ₁	sp	Vite Screw	Chiave Torx Torx key	50 GMTF	50 DMTX	50 SMTL	50 CMTF
AI	20,0	14,0	3,6	9,0	VTG 4.5X.75	KY T15	●	●	●	●
AJ	20,5	14,0	3,7	9,0	VTG 4.5X.75	KY T15	●	●	●	●
AK	21,0	14,0	3,9	9,0	VTG 4.5X.75	KY T15	●	●	●	●
AL	21,5	14,0	3,9	9,0	VTG 4.5X.75	KY T15	●	●	●	●
AM	22,0	15,4	3,9	9,0	VTH 5X.8X19.75	KY T20	●	●	●	●
AN	22,5	15,4	3,9	9,0	VTH 5X.8X19.75	KY T20	●	●	●	●
AO	23,0	15,4	4,2	10,0	VTH 5X.8X19.75	KY T20	●	●	●	●
AP	23,5	15,4	4,2	10,0	VTH 5X.8X19.75	KY T20	●	●	●	●
AQ	24,0	15,9	4,2	10,0	VTH 5X.8X21.75	KY T20	●	●	●	●
AR	24,5	15,9	4,5	11,0	VTH 5X.8X21.75	KY T20	●	●	●	●
AS	25,0	15,9	4,5	11,0	VTH 5X.8X21.75	KY T20	●	●	●	●
AT	25,5	15,8	4,5	11,0	VTH 5X.8X21.75	KY T20	●	●	●	●
AU	26,0	20,1	4,9	12,0	VTH 5X.8X23.40	KY T20	●	●	●	●
AV	26,5	20,1	4,9	12,0	VTH 5X.8X23.40	KY T20	●	●	●	●
AW	27,0	20,1	4,9	12,0	VTH 5X.8X23.40	KY T20	●	●	●	●
AX	27,5	20,1	4,9	12,0	VTH 5X.8X23.40	KY T20	●	●	●	●
AY	28,0	20,8	5,2	13,0	VTH 5X.8X23.40	KY T20	●	●	●	●
AZ	28,5	20,8	5,2	13,0	VTH 5X.8X23.40	KY T20	●	●	●	●
BA	29,0	20,8	5,2	13,0	VTH 5X.8X23.40	KY T20	●	●	●	●
BB	29,5	20,8	5,2	13,0	VTH 5X.8X23.40	KY T20	●	●	●	●
BC	30,0	22,4	5,6	14,0	VTI 6 x 1 x 27	KY T25	●	●	●	●
BD	30,5	22,4	5,6	14,0	VTI 6 x 1 x 27	KY T25	●	●	●	●
BE	31,0	22,4	5,8	14,0	VTI 6 x 1 x 27	KY T25	●	●	●	●
BF	31,5	22,4	5,8	14,0	VTI 6 x 1 x 27	KY T25	●	●	●	●
BG	32,0	23,2	6,0	15,0	VTI 6 x 1 x 28,5	KY T25	●	●	●	●
BG	● 32,5	23,2	6,0	15,0	VTI 6 x 1 x 28,5	KY T25	●	●	●	●
BH	● 33,0	23,2	6,2	15,0	VTI 6 x 1 x 28,5	KY T25	●	●	●	●
BH	● 33,5	23,2	6,2	15,0	VTI 6 x 1 x 28,5	KY T25	●	●	●	●
BI	● 34,0	23,2	6,2	15,0	VTI 6 x 1 x 28,5	KY T25	●	●	●	●
BI	● 34,5	23,2	6,3	15,0	VTI 6 x 1 x 28,5	KY T25	●	●	●	●
BJ	● 35,0	23,2	6,4	15,0	VTI 6 x 1 x 28,5	KY T25	●	●	●	●
BJ	● 35,5	23,2	6,5	15,0	VTI 6 x 1 x 28,5	KY T25	●	●	●	●
BK	● 36,0	23,9	6,6	16,0	VTI 6 x 1 x 32,5	KY T25	●	●	●	●
BK	● 36,5	23,9	6,7	16,0	VTI 6 x 1 x 32,5	KY T25	●	●	●	●
BL	● 37,0	23,9	6,8	16,0	VTI 6 x 1 x 32,5	KY T25	●	●	●	●
BL	● 37,5	23,9	6,9	16,0	VTI 6 x 1 x 32,5	KY T25	●	●	●	●
BM	● 38,0	23,9	7,0	16,0	VTI 6 x 1 x 32,5	KY T25	●	●	●	●
BM	● 38,5	23,9	7,0	16,0	VTI 6 x 1 x 32,5	KY T25	●	●	●	●
BN	● 39,0	23,9	7,1	16,0	VTI 6 x 1 x 32,5	KY T25	●	●	●	●
BN	● 39,5	23,9	7,2	16,0	VTI 6 x 1 x 32,5	KY T25	●	●	●	●
BN	● 40,0	23,9	7,3	16,0	VTI 6 x 1 x 32,5	KY T25	●	●	●	●

03/03

Esempio d'ordine: (50GMTF + 20) | Ordering example: (50GMTF + 20) ● Nuovi diametri | New diameters
 Vite inserto e chiave torx non inclusa | Insert Screw and torx key not included

RECORD AG DRILL 600

Inseri in metallo duro integrale per punte a fissaggio meccanico | Solid carbide inserts for indexable drills



**ILIX
NORM**
DIN

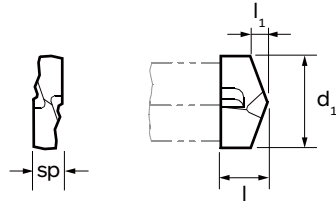

GRUPPO MATERIALI
MATERIAL GROUPS

MATERIALE | MATERIAL

RIVESTIMENTO | COATING

DIREZIONE TAGLIO | CUTTING DIRECTION

P | Acciai | Steels

M | Acciai Inossidabili | Stainless Steels

K | Ghise | Cast Irons

N | Metalli non ferrosi | Non-ferrous metals

S | Leghe resistenti al calore e Titanio | HRSA and Titanium

H | Acciai Temprati | Hardened Steels

M.D.I.-HM	M.D.I.-HM	M.D.I.-HM	M.D.I.-HM
TiAlN Futura	TiNOX	TL	TiAlN Futura
↻	↻	↻	↻
P	-	-	-
-	M	-	-
-	-	-	K
-	-	N	-
-	S	-	-
-	-	-	-

	d ₁ (h7)	l	l ₁	sp	Vite Screw	Chiave Torx Torx key	60 GMTF	60 DMTX	60 SMTL	60 CMTF
A	16,00	8,0	2,9	4,5	SRA 3X.35	KY T6	●	●	●	●
A	16,10	8,0	2,9	4,5	SRA 3X.35	KY T6	●	●	●	●
A	16,20	8,0	3,0	4,5	SRA 3X.35	KY T6	●	●	●	●
A	16,30	8,0	3,0	4,5	SRA 3X.35	KY T6	●	●	●	●
A	16,40	8,0	3,0	4,5	SRA 3X.35	KY T6	●	●	●	●
A	16,50	8,0	3,0	4,5	SRA 3X.35	KY T6	●	●	●	●
A	16,60	8,0	3,0	4,5	SRA 3X.35	KY T6	●	●	●	●
A	16,70	8,0	3,1	4,5	SRA 3X.35	KY T6	●	●	●	●
A	16,80	8,0	3,1	4,5	SRA 3X.35	KY T6	●	●	●	●
A	16,90	8,0	3,1	4,5	SRA 3X.35	KY T6	●	●	●	●
A	17,00	8,0	3,1	4,5	SRA 3X.35	KY T6	●	●	●	●
B	17,10	8,0	3,1	4,5	SRA 3X.35	KY T6	●	●	●	●
B	17,20	8,0	3,1	4,5	SRA 3X.35	KY T6	●	●	●	●
B	17,30	8,0	3,1	4,5	SRA 3X.35	KY T6	●	●	●	●
B	17,40	8,0	3,2	4,5	SRA 3X.35	KY T6	●	●	●	●
B	17,50	8,0	3,2	4,5	SRA 3X.35	KY T6	●	●	●	●
B	17,60	8,0	3,2	4,5	SRA 3X.35	KY T6	●	●	●	●
B	17,70	8,0	3,2	4,5	SRA 3X.35	KY T6	●	●	●	●
B	17,80	8,0	3,2	4,5	SRA 3X.35	KY T6	●	●	●	●
B	17,90	8,0	3,3	4,5	SRA 3X.35	KY T6	●	●	●	●
C	18,00	8,0	3,3	5,0	SRB 3X.35	KY T6	●	●	●	●
C	18,10	8,0	3,3	5,0	SRB 3X.35	KY T6	●	●	●	●
C	18,20	8,0	3,3	5,0	SRB 3X.35	KY T6	●	●	●	●
C	18,30	8,0	3,3	5,0	SRB 3X.35	KY T6	●	●	●	●
C	18,40	8,0	3,3	5,0	SRB 3X.35	KY T6	●	●	●	●
C	18,50	8,0	3,4	5,0	SRB 3X.35	KY T6	●	●	●	●
C	18,60	8,0	3,4	5,0	SRB 3X.35	KY T6	●	●	●	●

01/02 →

Esempio d'ordine: (60GMTF + 16) | Ordering example: (60GMTF + 16)
Chiave torx non inclusa | Torx key not included



**A
02**

	d ₁ (h7)	l	l ₁	sp	Vite Screw	Chiave Torx Torx key	60 GMTF	60 DMTX	60 SMTL	60 CMTF
C	18,70	8,0	3,4	5,0	SRB 3X.35	KY T6	●	●	●	●
C	18,80	8,0	3,4	5,0	SRB 3X.35	KY T6	●	●	●	●
C	18,90	8,0	3,4	5,0	SRB 3X.35	KY T6	●	●	●	●
C	19,00	8,0	3,5	5,0	SRB 3X.35	KY T6	●	●	●	●
D	19,10	8,0	3,5	5,0	SRB 3X.35	KY T6	●	●	●	●
D	19,20	8,0	3,5	5,0	SRB 3X.35	KY T6	●	●	●	●
D	19,30	8,0	3,5	5,0	SRB 3X.35	KY T6	●	●	●	●
D	19,40	8,0	3,5	5,0	SRB 3X.35	KY T6	●	●	●	●
D	19,50	8,0	3,5	5,0	SRB 3X.35	KY T6	●	●	●	●
D	19,60	8,0	3,6	5,0	SRB 3X.35	KY T6	●	●	●	●
D	19,70	8,0	3,6	5,0	SRB 3X.35	KY T6	●	●	●	●
D	19,80	8,0	3,6	5,0	SRB 3X.35	KY T6	●	●	●	●
D	19,90	8,0	3,6	5,0	SRB 3X.35	KY T6	●	●	●	●
D	20,00	8,0	3,6	5,0	SRB 3X.35	KY T6	●	●	●	●
E	20,50	8,8	3,7	5,5	SRB 3X.35	KY T6	●	●	●	●
E	21,00	8,8	3,8	5,5	SRB 3X.35	KY T6	●	●	●	●
F	21,50	8,8	3,9	5,5	SRB 3X.35	KY T6	●	●	●	●
F	22,00	8,8	4,0	5,5	SRB 3X.35	KY T6	●	●	●	●
F	22,50	8,8	4,1	5,5	SRB 3X.35	KY T6	●	●	●	●
G	23,00	10,0	4,2	6,3	SRC 3.5X.35	KY T7	●	●	●	●
G	23,50	10,0	4,3	6,3	SRC 3.5X.35	KY T7	●	●	●	●
G	24,00	10,0	4,4	6,3	SRC 3.5X.35	KY T7	●	●	●	●
H	24,50	10,0	4,5	6,3	SRC 3.5X.35	KY T7	●	●	●	●
H	25,00	10,0	4,5	6,3	SRC 3.5X.35	KY T7	●	●	●	●
H	25,50	10,0	4,6	6,3	SRC 3.5X.35	KY T7	●	●	●	●
I	26,00	11,6	4,7	7,3	SRD 4X.5	KY T8	●	●	●	●
I	26,50	11,6	4,8	7,3	SRD 4X.5	KY T8	●	●	●	●
I	27,00	11,6	5,9	7,3	SRD 4X.5	KY T8	●	●	●	●
I	27,50	11,6	5,0	7,3	SRD 4X.5	KY T8	●	●	●	●
L	28,00	11,6	5,1	7,3	SRD 4X.5	KY T8	●	●	●	●
L	28,50	11,6	5,2	7,3	SRD 4X.5	KY T8	●	●	●	●
L	29,00	11,6	5,3	7,3	SRD 4X.5	KY T8	●	●	●	●
L	29,50	11,6	5,4	7,3	SRD 4X.5	KY T8	●	●	●	●
M	30,00	13,6	5,5	8,5	SRE 4.5X.5	KY T8	●	●	●	●
M	30,50	13,6	5,6	8,5	SRE 4.5X.5	KY T8	●	●	●	●
M	31,00	16,6	5,6	8,5	SRE 4.5X.5	KY T8	●	●	●	●
M	31,50	13,6	5,7	8,5	SRE 4.5X.5	KY T8	●	●	●	●
M	32,00	13,6	5,8	8,5	SRE 4.5X.5	KY T8	■	■	■	■
N	32,50	13,6	5,9	8,5	SRE 4.5X.5	KY T8	■	■	■	■
N	33,00	13,6	6,0	8,5	SRE 4.5X.5	KY T8	■	■	■	■
N	33,50	13,6	6,1	8,5	SRE 4.5X.5	KY T8	■	■	■	■
N	34,00	13,6	6,2	8,5	SRE 4.5X.5	KY T8	■	■	■	■
N	34,50	13,6	6,2	8,5	SRE 4.5X.5	KY T8	■	■	■	■
O	35,00	16,0	6,4	10,0	SRF 5X.5	KY T10	■	■	■	■
O	36,00	16,0	6,6	10,0	SRF 5X.5	KY T10	■	■	■	■
O	37,00	16,0	6,7	10,0	SRF 5X.5	KY T10	■	■	■	■
O	37,50	16,0	6,8	10,0	SRF 5X.5	KY T10	■	■	■	■
P	38,00	16,0	6,9	10,0	SRF 5X.5	KY T10	■	■	■	■
P	39,00	16,0	7,1	10,0	SRF 5X.5	KY T10	■	■	■	■
P	40,00	16,0	7,3	10,0	SRF 5X.5	KY T10	■	■	■	■

02/02

Esempio d'ordine: (60GMTF + 22) | Ordering example: (60GMTF + 22)

Chiave torx non inclusa | Torx key not included

■ Fino ad esaurimento scorte | Till stocks last

▶ MODALITÀ MONTAGGIO INSERTI | INSERT MOUNTING MODE





Le punte con inserti a fissaggio meccanico della serie GTR3D, GTR4D, GSQ3D, GSQ4D, DHTR e DHMTR sono progettate per lavorazioni su acciaio, acciaio inossidabile, ghise e materiali non ferrosi.

The indexable insert drills GTR3D, GTR4D, GSQ3D, GSQ4D, DHTR and DHMTR series are designed for machining steel, stainless steel cast irons and non-ferrous materials.

Record INDEX DRILL



LA SERIE GTRD È DISPONIBILE NEI DIAMETRI DA 16 A 50 mm NELLA VERSIONE 3xD E 4xD CON INSERTI WCEX.

The GTRD series is available in diameters from 16 to 50 mm in the 3xD and 4xD version with WCEX inserts.

LA SERIE GSQD È DISPONIBILE NEI DIAMETRI DA 16 A 50 mm NELLA VERSIONE 3xD E 4xD CON INSERTI SPKX.

The GSQD series is available in diameters 16 to 50 mm in the 3xD and 4xD version with SPKX inserts.

LA SERIE DHTR È DISPONIBILE NEI DIAMETRI DA 25 A 45 mm NELLA VERSIONE 8xD CON INSERTI WCEX.

The DHTR series is available in diameters from 25 to 45 mm in the 8xD version with WCEX inserts.

LA SERIE DHMTR È DISPONIBILE NEI DIAMETRI DA 45 A 180 mm CON INSERTI WCEX.

The DHMTR series is available in diameters from 45 to 180 mm with WCEX inserts.

IL DESIGN ESCLUSIVO GARANTISCE UN'ELEVATA PRODUTTIVITÀ E VERSATILITÀ.

The unique design guarantees high productivity and versatility.

GLI AMPI VANI ASSICURANO UN'EFFICIENTE EVACUAZIONE DEL TRUCIOLO AUMENTANDO LA DURATA DEL CORPO PUNTA.

The large chip pockets ensure efficient chip evacuation increasing the lifetime of the drill body.

DISPONIBILITÀ DI GEOMETRIE E QUALITÀ DI INSERTI WCEX E SPKX IN GRADO DI LAVORARE LA MAGGIOR PARTE DEI MATERIALI.

Availability of WCEX and SPKX insert geometries and grades suitable for machining most materials.

PUNTA PILOTA IN HSS-Co RIVESTITA AL TiN, CON TECNICA PVD, OFFRE UN'ELEVATA STABILITÀ E RETTILINEITÀ ALLA PUNTA IN FASE DI LAVORAZIONE.

HSS-Co pilot drill, TiN coated with pvd technique, offers high stability and straightness to the drill during machining.

RECORD INDEX DRILL "GTR3D"

Corpi a fissaggio meccanico per inserti in metallo duro | Indexable body for solid carbide inserts



ILIX NORM
DIN

≤3xd

9766

A

⊕

P. 198

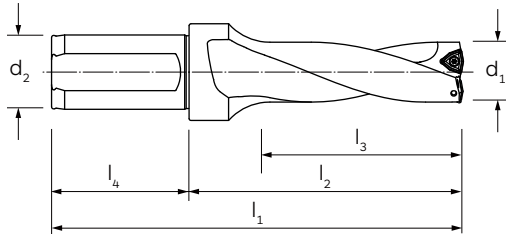

A
02

MATERIALE | MATERIAL

RIVESTIMENTO | COATING

DIREZIONE TAGLIO | CUTTING DIRECTION

DISPONIBILITÀ E COMPATIBILITÀ DIAMETRO CORPO/INSERTO BODY DIAMETER/INSERT AVAILABILITY AND COMPATIBILITY



Ordinare separatamente gli inserti | Inserts to be ordered separately

		WCEX.....LC	WCEX.....MC
	Ø 16 ÷ 20	-	●
	Ø 20,5 ÷ 25	-	●
	Ø 25,5 ÷ 30	●	●
	Ø 31 ÷ 41	●	●
	Ø 42 ÷ 50	-	●
Maggiori dettagli a pagina More details on page		175	176

d ₁	d ₂	l ₁	l ₂	l ₃	l ₄	GTR3D
*16,0	25	132	76	48	56	●
*16,5	25	134	78	50	56	●
*17,0	25	135	79	51	56	●
*17,5	25	137	81	53	56	●
*18,0	25	138	82	54	56	●
*18,5	25	140	84	56	56	●
*19,0	25	141	85	57	56	●
*19,5	25	143	87	59	56	●
*20,0	25	144	88	60	56	●
20,5	25	146	90	62	56	●
21,0	25	147	91	63	56	●
21,5	25	149	93	65	56	●
22,0	25	150	94	66	56	●
22,5	25	152	96	68	56	●
23,0	25	153	97	69	56	●
23,5	25	155	99	71	56	●
24,0	25	156	100	72	56	●
24,5	25	158	102	74	56	●
25,0	25	159	103	75	56	●
25,5	32	170	110	77	60	●
26,0	32	171	111	78	60	●
26,5	32	173	113	80	60	●
27,0	32	174	114	81	60	●
27,5	32	176	116	83	60	●
28,0	32	177	117	84	60	●

d ₁	d ₂	l ₁	l ₂	l ₃	l ₄	GTR3D
28,5	32	179	119	86	60	●
29,0	32	180	120	87	60	●
29,5	32	182	122	89	60	●
30,0	32	183	123	90	60	●
31,0	32	186	126	93	60	●
32,0	32	189	129	96	60	●
33,0	32	192	132	99	60	●
34,0	32	195	135	102	60	●
35,0	32	198	138	105	60	●
36,0	32	201	141	108	60	●
37,0	32	204	144	111	60	●
38,0	32	207	147	114	60	●
39,0	32	210	150	117	60	●
40,0	32	213	153	120	60	●
41,0	32	216	156	123	60	●
42,0	40	234	164	126	70	●
43,0	40	237	167	129	70	●
44,0	40	240	170	132	70	●
45,0	40	243	173	135	70	●
46,0	40	246	176	138	70	●
47,0	40	249	179	141	70	●
48,0	40	252	182	144	70	●
49,0	40	255	185	147	70	●
50,0	40	258	188	150	70	●

Esempio d'ordine: (GTR3D + 16) | Ordering example: (GTR3D + 16)

* (d₂ = 20mm) Fino ad esaurimento scorte | Until stocks are exhausted

Vite inserto e chiave torx incluse, inserti non inclusi | Insert Screw and torx key included, inserts not included

A
02

NEW

**ILIX
NORM**
DIN

≤3x d

9766



P. 198



ACCIAIO
-
↻

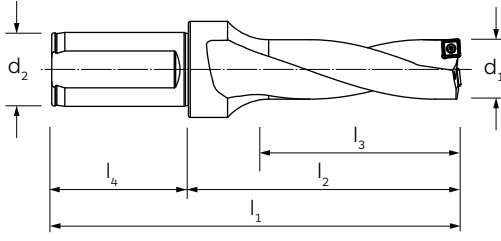

MATERIALE | MATERIAL

RIVESTIMENTO | COATING

DIREZIONE TAGLIO | CUTTING DIRECTION

DISPONIBILITÀ E COMPATIBILITÀ DIAMETRO CORPO/INSERTO
BODY DIAMETER/INSERT AVAILABILITY AND COMPATIBILITY



Ordinare separatamente gli inserti Inserts to be ordered separately		SPKX.....MC	SPKX.....MC	SPHX.....LN
	Ø 16 ÷ 21,5	SP..X 060204...	●	●
	Ø 22 ÷ 27,5	SPKX 07T308...	●	-
	Ø 28 ÷ 33	SPKX 090408...	●	-
	Ø 34 ÷ 41	SPKX 110408...	●	-
	Ø 42 ÷ 50	SPKX 140512...	●	-
Riferimento pagina catalogo Catalog page reference		177	178	178

d ₁	d ₂	l ₁	l ₂	l ₃	l ₄	GSQ3D
16,0	25	132	76	48	56	●
16,5	25	134	78	50	56	●
17,0	25	135	79	51	56	●
17,5	25	137	81	53	56	●
18,0	25	138	82	54	56	●
18,5	25	140	84	56	56	●
19,0	25	141	85	57	56	●
19,5	25	143	87	59	56	●
20,0	25	144	88	60	56	●
20,5	25	146	90	62	56	●
21,0	25	147	91	63	56	●
21,5	25	149	93	65	56	●
22,0	32	159	99	66	60	●
22,5	32	161	101	68	60	●
23,0	32	162	102	69	60	●
23,5	32	164	104	71	60	●
24,0	32	165	105	72	60	●
24,5	32	167	107	74	60	●
25,0	32	168	108	75	60	●
25,5	32	170	110	77	60	●
26,0	32	171	111	78	60	●
26,5	32	173	113	80	60	●
27,0	32	174	114	81	60	●
27,5	32	176	116	83	60	●
28,0	32	177	117	84	60	●

d ₁	d ₂	l ₁	l ₂	l ₃	l ₄	GSQ3D
28,5	32	179	119	86	60	●
29,0	32	180	120	87	60	●
29,5	32	183	123	89	60	●
30,0	32	185	125	90	60	●
31,0	32	188	128	93	60	●
32,0	32	191	131	96	60	●
33,0	32	194	134	99	60	●
34,0	40	212	142	102	70	●
35,0	40	215	145	105	70	●
36,0	40	218	148	108	70	●
37,0	40	221	151	111	70	●
38,0	40	224	154	114	70	●
39,0	40	227	157	117	70	●
40,0	40	230	160	120	70	●
41,0	40	233	163	123	70	●
42,0	40	236	166	126	70	●
43,0	40	239	169	129	70	●
44,0	40	242	172	132	70	●
45,0	40	245	175	135	70	●
46,0	40	248	178	138	70	●
47,0	40	251	181	141	70	●
48,0	40	254	184	144	70	●
49,0	40	257	187	147	70	●
50,0	40	260	190	150	70	●

Esempio d'ordine: (GSQ3D + 16) | Ordering example: (GSQ3D + 16)

Vite inserto e chiave torx include, inserti non inclusi | Insert Screw and torx key included, inserts not included

RECORD INDEX DRILL "GTR4D"

Corpi a fissaggio meccanico per inserti in metallo duro | Indexable body for solid carbide inserts

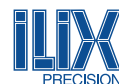

NEW

**ILIX
NORM**
DIN

≤4Xd

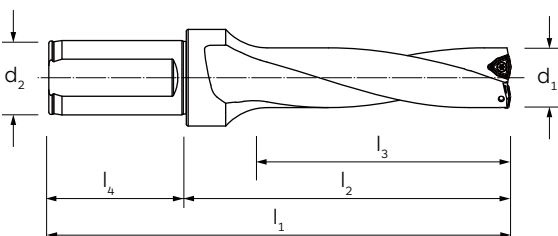

**A
02**



ACCIAIO

-

↻

MATERIALE | MATERIAL

RIVESTIMENTO | COATING

DIREZIONE TAGLIO | CUTTING DIRECTION

DISPONIBILITÀ E COMPATIBILITÀ DIAMETRO CORPO/INSERTO BODY DIAMETER/INSERT AVAILABILITY AND COMPATIBILITY



Ordinare separatamente gli inserti | Inserts to be ordered separately

				WCEX.....LC	WCEX.....MC
	Ø 16 ÷ 20	WCEX 030204...		-	●
	Ø 20,5 ÷ 25,5	WCEX 040204...		-	●
	Ø 26 ÷ 30	WCEX 050308...		●	●
	Ø 31 ÷ 41	WCEX 06T308...		●	●
	Ø 42 ÷ 50	WCEX 080408...		-	●
Maggiori dettagli a pagina More details on page				175	176

d ₁	d ₂	l ₁	l ₂	l ₃	l ₄	GTR4D
16,0	25	148	92	64	56	●
16,5	25	150	94	66	56	●
17,0	25	152	96	68	56	●
17,5	25	154	98	70	56	●
18,0	25	156	100	72	56	●
18,5	25	158	102	74	56	●
19,0	25	160	104	76	56	●
19,5	25	162	106	78	56	●
20,0	25	164	108	80	56	●
20,5	25	166	110	82	56	●
21,0	25	168	112	84	56	●
21,5	25	170	114	86	56	●
22,0	32	181	121	88	60	●
22,5	32	183	123	90	60	●
23,0	32	185	125	92	60	●
23,5	32	187	127	94	60	●
24,0	32	189	129	96	60	●
24,5	32	191	131	98	60	●
25,0	32	193	133	100	60	●
25,5	32	195	135	102	60	●
26,0	32	197	137	104	60	●
26,5	32	199	139	106	60	●
27,0	32	201	141	108	60	●
27,5	32	203	143	110	60	●
28,0	32	205	145	112	60	●

d ₁	d ₂	l ₁	l ₂	l ₃	l ₄	GTR4D
28,5	32	207	147	114	60	●
29,0	32	210	150	116	60	●
29,5	32	213	153	118	60	●
30,0	32	215	155	120	60	●
31,0	32	219	159	124	60	●
32,0	32	223	163	128	60	●
33,0	32	227	167	132	60	●
34,0	40	246	176	136	70	●
35,0	40	250	180	140	70	●
36,0	40	254	184	144	70	●
37,0	40	258	188	148	70	●
38,0	40	262	192	152	70	●
39,0	40	266	196	156	70	●
40,0	40	270	200	160	70	●
41,0	40	274	204	164	70	●
42,0	40	278	208	168	70	●
43,0	40	282	212	172	70	●
44,0	40	286	216	176	70	●
45,0	40	290	220	180	70	●
46,0	40	294	224	184	70	●
47,0	40	298	228	188	70	●
48,0	40	302	232	192	70	●
49,0	40	306	236	196	70	●
50,0	40	310	240	200	70	●

Esempio d'ordine: (GTR4D + 16) | Ordering example: (GTR4D + 16)

Vite inserto e chiave torx incluse, inserti non inclusi | Insert Screw and torx key included, inserts not included

A
02

NEW

**ILIX
NORM**
DIN

$\leq 4 \times d$

9766

A

P. 198



ACCIAIO
-
↻

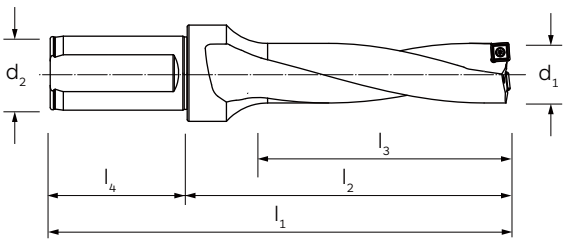

MATERIALE | MATERIAL

RIVESTIMENTO | COATING

DIREZIONE TAGLIO | CUTTING DIRECTION

DISPONIBILITÀ E COMPATIBILITÀ DIAMETRO CORPO/INSERTO
BODY DIAMETER/INSERT AVAILABILITY AND COMPATIBILITY



Ordinare separatamente gli inserti Inserts to be ordered separately		SPKX.....MC	SPKX.....MC	SPHX.....LN
	Ø 16 ÷ 21,5	SP..X 060204...	●	●
	Ø 22 ÷ 27,5	SPKX 07T308...	●	-
	Ø 28 ÷ 33	SPKX 090408...	●	-
	Ø 34 ÷ 41	SPKX 110408...	●	-
	Ø 42 ÷ 50	SPKX 140512...	●	-
Riferimento pagina catalogo Catalog page reference		177	178	178

d ₁	d ₂	l ₁	l ₂	l ₃	l ₄	GSQ4D
16,0	25	148	92	64	56	●
16,5	25	150	94	66	56	●
17,0	25	152	96	68	56	●
17,5	25	154	98	70	56	●
18,0	25	156	100	72	56	●
18,5	25	158	102	74	56	●
19,0	25	160	104	76	56	●
19,5	25	162	106	78	56	●
20,0	25	164	108	80	56	●
20,5	25	166	110	82	56	●
21,0	25	168	112	84	56	●
21,5	25	170	114	86	56	●
22,0	32	181	121	88	60	●
22,5	32	183	123	90	60	●
23,0	32	185	125	92	60	●
23,5	32	187	127	94	60	●
24,0	32	189	129	96	60	●
24,5	32	191	131	98	60	●
25,0	32	193	133	100	60	●
25,5	32	195	135	102	60	●
26,0	32	197	137	104	60	●
26,5	32	199	139	106	60	●
27,0	32	201	141	108	60	●
27,5	32	203	143	110	60	●
28,0	32	205	145	112	60	●

d ₁	d ₂	l ₁	l ₂	l ₃	l ₄	GSQ4D
28,5	32	207	147	114	60	●
29,0	32	210	150	116	60	●
29,5	32	213	153	118	60	●
30,0	32	215	155	120	60	●
31,0	32	219	159	124	60	●
32,0	32	223	163	128	60	●
33,0	32	227	167	132	60	●
34,0	40	246	176	136	70	●
35,0	40	250	180	140	70	●
36,0	40	254	184	144	70	●
37,0	40	258	188	148	70	●
38,0	40	262	192	152	70	●
39,0	40	266	196	156	70	●
40,0	40	270	200	160	70	●
41,0	40	274	204	164	70	●
42,0	40	278	208	168	70	●
43,0	40	282	212	172	70	●
44,0	40	286	216	176	70	●
45,0	40	290	220	180	70	●
46,0	40	294	224	184	70	●
47,0	40	298	228	188	70	●
48,0	40	302	232	192	70	●
49,0	40	306	236	196	70	●
50,0	40	310	240	200	70	●

Esempio d'ordine: (GSQ4D + 16) | Ordering example: (GSQ4D + 16)

Vite inserto e chiave torx include, inserti non inclusi | Insert Screw and torx key included, inserts not included

RECORD INDEX DRILL "DHTR"

Corpi a fissaggio meccanico per inserti in metallo duro | Indexable body for solid carbide inserts

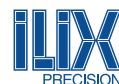

**ILIX
NORM**

DIN

≤8Xd



9766



A



P. 200

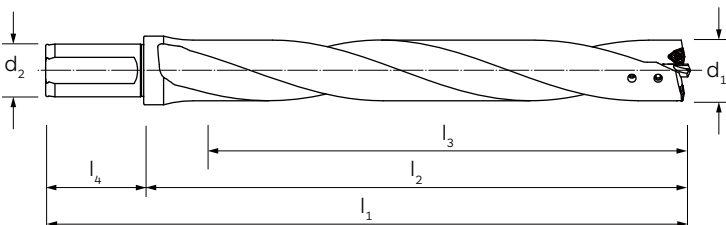

ACCIAIO

-



MATERIALE | MATERIAL

RIVESTIMENTO | COATING

DIREZIONE TAGLIO | CUTTING DIRECTION

DISPONIBILITÀ E COMPATIBILITÀ DIAMETRO CORPO/INSERTO BODY DIAMETER/INSERT AVAILABILITY AND COMPATIBILITY



Ordinare separatamente gli inserti/punta pilota | Inserts/pilot drill to be ordered separately



	WCEX.....LC	WCEX.....MC
WCEX 030204...	-	●
WCEX 040204...	-	●
WCEX 050308...	●	●
WCEX 06T308...	●	●

Maggiori dettagli a pagina | More details on page

175

176

d ₁	d ₂	l ₁	l ₂	l ₃	l ₄	Inserto Insert	Punta pilota Pilot Drill	DHTR
25	32	310	250	220	60	WCEX 030204...	DHP 6x30	●
26	32	310	250	220	60	WCEX 040204...	DHP 6x30	●
27	32	310	250	220	60	WCEX 040204...	DHP 6x30	●
28	32	310	250	220	60	WCEX 040204...	DHP 6x30	●
29	32	310	250	220	60	WCEX 040204...	DHP 6x30	●
30	32	310	250	220	60	WCEX 040204...	DHP 6x30	●
31	32	350	290	260	60	WCEX 050308...	DHP 8x35	●
32	32	350	290	260	60	WCEX 050308...	DHP 8x35	●
33	32	350	290	260	60	WCEX 050308...	DHP 8x35	●
34	32	350	290	260	60	WCEX 050308...	DHP 8x35	●
35	32	350	290	260	60	WCEX 050308...	DHP 8x35	●
36	32	390	330	300	60	WCEX 050308...	DHP 8x35	●
37	32	390	330	300	60	WCEX 050308...	DHP 8x35	●
38	32	390	330	300	60	WCEX 050308...	DHP 8x35	●
39	32	390	330	300	60	WCEX 050308...	DHP 8x35	●
40	32	390	330	300	60	WCEX 050308...	DHP 8x35	●
*41	40	445	375	340	70	WCEX 06T308...	DHP 10x35	●
*42	40	445	375	340	70	WCEX 06T308...	DHP 10x35	●
*43	40	445	375	340	70	WCEX 06T308...	DHP 10x35	●
*44	40	445	375	340	70	WCEX 06T308...	DHP 10x35	●
*45	40	445	375	340	70	WCEX 06T308...	DHP 10x35	●

*Montaggio cartucce DHTR CI-CE, vedi pagina 166 | Mounting Cartridges for DHTR CI-CE, see page 166

Esempio d'ordine: (DHTR + 25) | Ordering example: (DHTR + 25)

Vite inserto e chiave torx incluse, inserti non inclusi | Insert Screw and torx key included, inserts not included

**A
02**

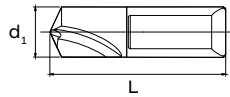
► Punta pilota (DHTR) | Pilot Drill (DHTR)

Gamma Range DHTR	Gamma Range	d ₁	L	Materiale Material	Rivestimento Coating	Refrigerazione Coolant	DHP
25 ÷ 30	6x30	6	30	HSS-Co	TiN	✘	●
31 ÷ 40	8x35	8	35	HSS-Co	TiN	✓	●
41 ÷ 45	10x35	10	35	HSS-Co	TiN	✓	●

Esempio d'ordine: (DHP + 6x30) | **Ordering example:** (DHP + 6x30)

Regolazione punta pilota a pagina 181 | Pilot drill adjustment on page 181

► Viti per regolazione altezza della punta pilota (DHTR) | Adjustment Screw for Pilot Drill (DHTR)

Gamma Range DHTR	Gamma Range DHP	Dimensioni Dimensions	GAR
Ø 25 ÷ 30	6x30	5X8	●
Ø 31 ÷ 40	8x35	6X10	●
Ø 41 ÷ 45	10x35	8X12	●

Esempio d'ordine: (GAR + 5X8) | **Ordering example:** (GAR + 5X8)

► Viti per bloccaggio della punta pilota (DHTR) | Clamping bolt for pilot drill (DHTR)

Gamma Range DHTR	Gamma Range DHP	Dimensioni Dimensions	GAF
Ø 25 ÷ 30	6x30	5X8	●
Ø 31 ÷ 40	8x35	6X10	●
Ø 41 ÷ 45	10x35	8X12	●

Esempio d'ordine: (GAF + 5X8) | **Ordering example:** (GAF + 5X8)

► Cartucce interne ed esterne (DHTR) | Internal and external cartridges (DHTR)

Gamma Range DHTR	Cartuccia Int. Int. Cartridge	Cartuccia Ext. Ext. Cartridge	Vite Cartuccia Cartridge scrow	Inserto Insert	Vite Inserto Screw insert	CI-CE
Ø 41	CI 4145	CE 4141	VTS 5X10	WCEX 06T308..	VT 3.5X0.6	●
Ø 42	CI 4145	CE 4142	VTS 5X10	WCEX 06T308..	VT 3.5X0.6	●
Ø 43	CI 4145	CE 4143	VTS 5X10	WCEX 06T308..	VT 3.5X0.6	●
Ø 44	CI 4145	CE 4144	VTS 5X10	WCEX 06T308..	VT 3.5X0.6	●
Ø 45	CI 4145	CE 4145	VTS 5X10	WCEX 06T308..	VT 3.5X0.6	●

Esempio d'ordine: (CI + 41-45) | **Ordering example:** (CI + 41-45)

RECORD INDEX DRILL "DHMTR"

Corpi a fissaggio meccanico per inserti in metallo duro | Indexable body for solid carbide inserts

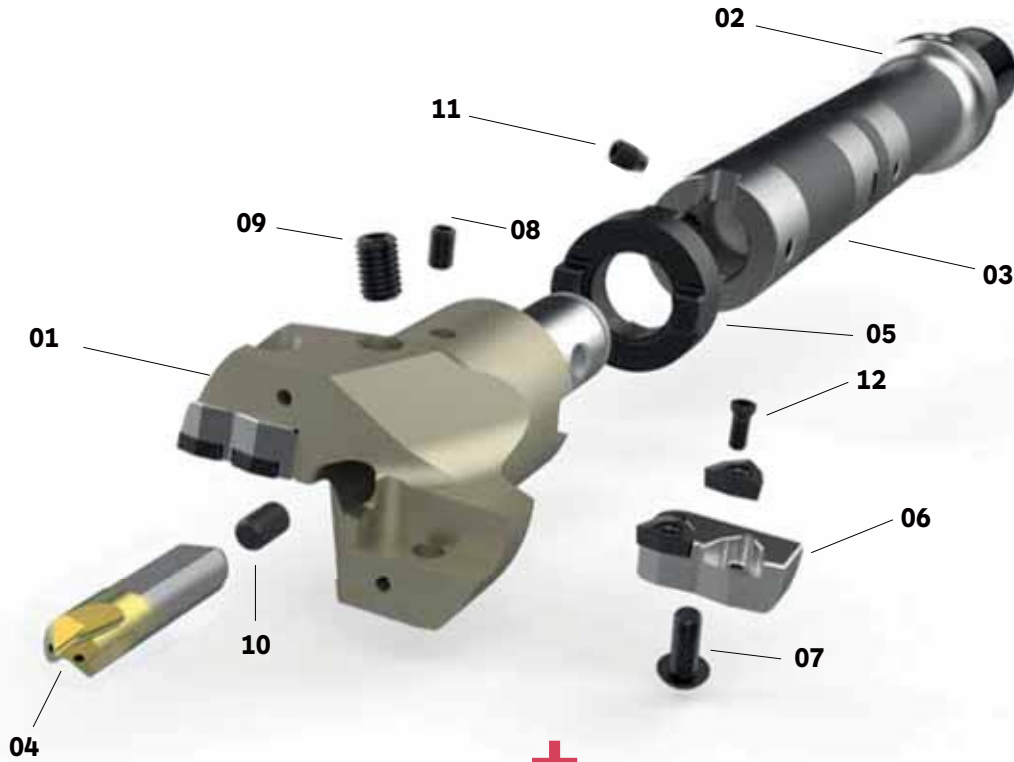

	+	
Corpo punta (DHMTR)	01	Drill Body (DHMTR)
Attacco base (DHMSH)	02	(DHMSH) Shank
Prolunga (DHMEX)	03	(DHMEX) Extension
Punta pilota (DHP)	04	Pilot Drill (DHP)
Anello di trascinamento (DHRG)	05	Drive Ring (DHRG)
Cartuccia Interna/Esterna (CI/CE)	06	Cartdrige Inner/Outer (CI/CE)
Vite bloccaggio cartuccia (VTSM)	07	Fixation Cartdrige Screw (VTSM)
Vite di sicurezza punta pilota (GASM)	08	Fixing Screw for Pilot Drill (GASM)
Vite bloccaggio punta pilota (GAFM)	09	Clamping Bolt for Pilot Drill (GAFM)
Vite regolazione assiale punta pilota (GARM)	10	Adjustment Screw for Pilot Drill (GARM)
Vite bloccaggio punta (GABM)	11	Fixation drill Screw (GABM)
Vite inserto (VT)	12	Insert screw (VT)
	+	

A
02

NEW

**ILIX
NORM**
DIN



P. 200

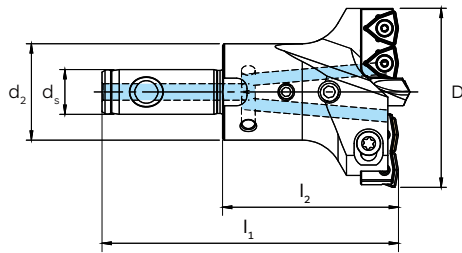

Corpo punta (DHMTR)
(DHMTR) Drill Body

01

ACCIAIO
-
↻

MATERIALE | MATERIAL

RIVESTIMENTO | COATING

DIREZIONE TAGLIO | CUTTING DIRECTION

DISPONIBILITÀ E COMPATIBILITÀ DIAMETRO CORPO/INSERTO
BODY DIAMETER/INSERT AVAILABILITY AND COMPATIBILITY



Ordinare separatamente gli inserti/punta pilota | Inserts/pilot drill to be ordered separately



	WCEX.....LC	WCEX.....MC
WCEX 030204...	-	●
WCEX 040204...	-	●
WCEX 050308...	●	●
WCEX 06T308...	●	●
WCEX 080408...	-	●
	175	176

Maggiori dettagli a pagina | More details on page

	D (Min-Max)	d ₂	d _s	l ₂	l ₁	Cartuccia Int. Int. Cartridge	Cartuccia Est. Ext. Cartridge	Inserto Insert	Punta pilota Pilot Drill	DHMTR
2 Inserti per cartuccia 2 Inserts per cartridge										
A	45-50	28	13	50	85	CI 45-50	CE 45-50	WCEX 030204..	DHP 10X35	●
B	50-55	28	13	50	85	CI 50-55	CE 50-55	WCEX 030204..	DHP 10X35	●
C	55-60	32	16	60	100	CI 55-60	CE 55-60	WCEX 040204..	DHP 12X38	●
D	60-65	32	16	60	100	CI 60-65	CE 60-65	WCEX 050308..	DHP 12X38	●
E	65-70	32	16	60	100	CI 65-70	CE 65-70	WCEX 050308..	DHP 12X38	●
F	70-75	40	22	70	115	CI 70-75	CE 70-75	WCEX 050308..	DHP 12X38	●
G	75-80	40	22	70	115	CI 75-80	CE 75-80	WCEX 06T308..	DHP 16X45	●
H	80-85	40	22	70	115	CI 80-85	CE 80-85	WCEX 06T308..	DHP 16X45	●
I	85-90	48	27	70	120	CI 85-90	CE 85-90	WCEX 06T308..	DHP 16X45	●
L	90-95	48	27	70	120	CI 90-95	CE 90-95	WCEX 06T308..	DHP 16X45	●
M	95-100	48	27	70	120	CI 95-100	CE 95-100	WCEX 06T308..	DHP 16X45	●
3 Inserti per cartuccia 3 Inserts per cartridge										
N	100-105	58	32	80	130	CI 100-105	CE 100-105	WCEX 050308..	DHP 20X45	●
O	105-110	58	32	80	130	CI 105-110	CE 105-110	WCEX 06T308..	DHP 20X45	●
P	110-115	58	32	80	130	CI 110-115	CE 110-115	WCEX 06T308..	DHP 20X45	●
Q	115-120	70	40	90	145	CI 115-120	CE 115-120	WCEX 06T308..	DHP 20X45	●
R	120-125	70	40	90	145	CI 120-125	CE 120-125	WCEX 06T308..	DHP 25X56	●
S	125-130	70	40	90	145	CI 125-130	CE 125-130	WCEX 06T308..	DHP 25X56	●
T	● 130-135	70	40	90	145	CI 130-135	CE 130-135	WCEX 06T308	DHP 25X56	●
U	● 135-140	70	40	90	145	CI 135-140	CE 135-140	WCEX 06T308	DHP 25X56	●
V	● 140-150	80	50	100	160	CI 140-150	CE 140-150	WCEX 080408	DHP 25X56	●
W	● 150-160	80	50	100	160	CI 150-160	CE 150-160	WCEX 080408	DHP 25X56	●
X	● 160-170	80	50	100	160	CI 160-170	CE 160-170	WCEX 080408	DHP 30X68	●
Y	● 170-180	80	50	100	160	CI 170-180	CE 170-180	WCEX 080408	DHP 30X68	●

Esempio d'ordine: (DHMTR + 45-50) | **Ordering example:** (DHMTR + 45-50) • Nuovi diametri | New diameters
Vite inserto e chiave torx include, inserti non inclusi | Insert Screw and torx key included, inserts not included

RECORD INDEX DRILL "DHMTR"

Accessori per punte modulari | Accessories for modular drills

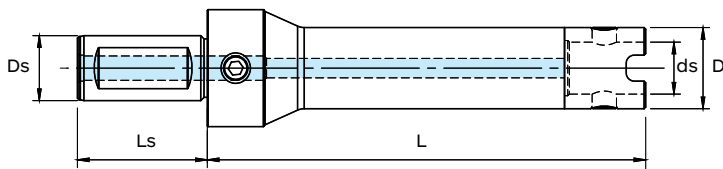
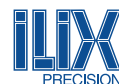

Attacco Base (DHMSH)
(DHMSH) Shank **02**



ACCIAIO

-



MATERIALE | MATERIAL

RIVESTIMENTO | COATING

DIREZIONE TAGLIO | CUTTING DIRECTION

	Gamma Range	ds	Ds	D	L	Ls	Anello di trascinamento Drive ring	DHMSH
A-B	13x115	13	32	28	115	70	DHRG 28	●
A-B	13x200	13	32	28	200	70	DHRG 28	●
A-B	13x300	13	32	28	300	70	DHRG 28	●
C-D-E	16x125	16	40	32	125	80	DHRG 32	●
C-D-E	16x200	16	40	32	200	80	DHRG 32	●
C-D-E	16x300	16	40	32	300	80	DHRG 32	●
F-G-H	22x148	22	40	40	148	80	DHRG 40	●
F-G-H	22x200	22	40	40	200	80	DHRG 40	●
F-G-H	22x300	22	40	40	300	80	DHRG 40	●
I-L-M	27x168	27	40	48	168	80	DHRG 48	●
I-L-M	27x300	27	40	48	300	80	DHRG 48	●
N-O-P	32x186	32	40	58	186	80	DHRG 58	●
N-O-P	32x300	32	40	58	300	80	DHRG 58	●
Q-R-S-T-U	40x186	40	50	70	186	80	DHRG 70	●
Q-R-S-T-U	40x300	40	50	70	300	80	DHRG 70	●
V-W-X-Y	● 50x184	50	50	80	184	80	DHRG 80	●
V-W-X-Y	● 50x300	50	50	80	300	80	DHRG 80	●

Esempio d'ordine: (DHMSH + 13x115) | Ordering example: (DHMSH + 13x115)

● Nuove misure | New Measures

Anello di trascinamento non incluso | Drive ring not included

A
02

NEW
Ø

**ILIX
NORM**
DIN

A

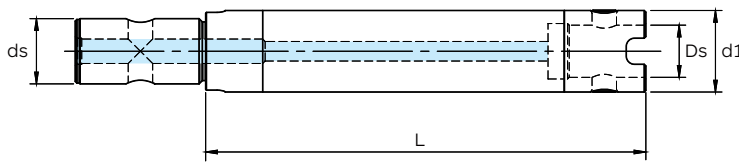

Prolunga (DHMEX)
(DHMEX) Extension **03**



- ACCIAIO
-
- ↻

MATERIALE | MATERIAL

RIVESTIMENTO | COATING

DIREZIONE TAGLIO | CUTTING DIRECTION

	Gamma Range	ds	Ds	D1	L	Anello di trascinamento Drive ring	DHMEX
A-B	13x115	13	13	28	115	DHRG 28	●
A-B	13x150	13	13	28	150	DHRG 28	●
A-B	13x200	13	13	28	200	DHRG 28	●
A-B	13x300	13	13	28	300	DHRG 28	●
C-D-E	16x115	16	16	32	115	DHRG 32	●
C-D-E	16x200	16	16	32	200	DHRG 32	●
C-D-E	16x300	16	16	32	300	DHRG 32	●
F-G-H	22x113	22	22	40	113	DHRG 40	●
F-G-H	22x200	22	22	40	200	DHRG 40	●
F-G-H	22x300	22	22	40	300	DHRG 40	●
I-L-M	27x113	27	27	48	113	DHRG 48	●
I-L-M	27x200	27	27	48	200	DHRG 48	●
I-L-M	27x300	27	27	48	300	DHRG 48	●
N-O-P	32x186	32	32	58	186	DHRG 58	●
N-O-P	32x300	32	32	58	300	DHRG 58	●
Q-R-S-T-U	40x186	40	40	70	186	DHRG 70	●
Q-R-S-T-U	40x300	40	40	70	300	DHRG 70	●
Q-R-S-T-U	40x500	40	40	70	500	DHRG 70	●
V-W-X-Y	● 50x204	50	50	80	204	DHRG 80	●
V-W-X-Y	● 50x300	50	50	80	300	DHRG 80	●
V-W-X-Y	● 50x500	50	50	80	500	DHRG 80	●

Esempio d'ordine: (DHMEX + 13x115) | **Ordering example:** (DHMEX + 13x115)
Anello di trascinamento non incluso | Drive ring not included

● Nuove misure | New Measures

RECORD INDEX DRILL "DHMTR"

Accessori per punte modulari | Accessories for modular drills

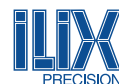

NEW
Ø

**ILIX
NORM**
DIN

► Punta pilota | Pilot Drill



04



	Gamma Range	d ₁	L	Materiale Material	Rivestimento Coating	Refrigerazione Coolant	DHP
A-B	10x35	10	35	HSS-Co	TiN	✓	●
D-E-F	12x38	12	38	HSS-Co	TiN	✓	●
G-H-I-L-M	16x45	16	45	HSS-Co	TiN	✓	●
N-O-P-Q	20x45	20	45	HSS-Co	TiN	✓	●
R-S-T-U-V-W	25x56	25	56	HSS-Co	TiN	✓	●
X-Y	● 30x68	30	68	HSS-Co	TiN	✓	●

Esempio d'ordine: (DHP + 10x35) | **Ordering example:** (DHP + 10x35)
Regolazione punta pilota a pagina 181 | Pilot drill adjustment on page 181

● Nuove misure | New Measures

NEW
Ø

**ILIX
NORM**
DIN

► Anello di trascinamento | Drive ring

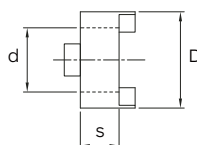

05



	Gamma Range	D	d	s	DHRG
A-B	28-13	28	13	10	●
C-D-E	32-16	32	16	10	●
F-G-H	40-22	40	22	12	●
I-L-M	48-27	48	27	12	●
N-O-P	58-32	58	32	14	●
Q-R-S-T-U	70-40	70	40	14	●
V-W-X-Y	● 80-50	80	50	16	●

Esempio d'ordine: (DHRG + 28-13) | **Ordering example:** (DHRG + 28-13)

● Nuove misure | New Measures

A
02

**ILIX
NORM**

DIN

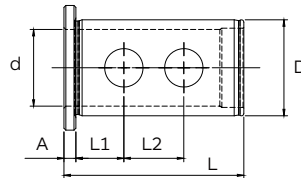

► **Bussola di riduzione** | Reducer Drill Sleeves

DHMSH	Gamma Range	D	d	L	L1	L2	A	DHMBS
-	32-20	32	20	65	20	-	5	●
-	32-25	32	25	65	20	20	5	●
-	40-20	40	20	75	20	-	5	●
-	40-25	40	25	75	20	25	5	●
13x...	40-32	40	32	75	20	25	5	●

Esempio d'ordine: (DHMBS + 40-32) | Ordering example: (DHMBS + 40-32)

NEW

**ILIX
NORM**

DIN

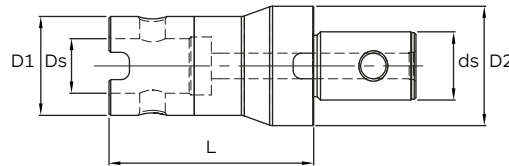

► **Riduzioni** | Reducer

	Gamma Range	ds	Ds	D1	D2	L	Anello di trascinamento (Ø D1) Drive ring	Anello di trascinamento (Ø D2) Drive ring	DHMRD
C-D-E	16-13	16	13	28	32	100	DHRG 28	DHRG 32	●
F-G-H	22-16	22	16	32	40	100	DHRG 32	DHRG 40	●
I-L-M	27-22	27	22	40	48	100	DHRG 40	DHRG 48	●
N-O-P	32-13	32	13	28	58	100	DHRG 28	DHRG 58	●
N-O-P	32-16	32	16	32	58	100	DHRG 32	DHRG 58	●
N-O-P	32-22	32	22	40	58	100	DHRG 40	DHRG 58	●
N-O-P	32-27	32	27	48	58	100	DHRG 48	DHRG 58	●
Q-R-S-T-U	40-32	40	32	58	70	100	DHRG 58	DHRG 70	●
V-W-X-Y	● 50-27	50	27	48	80	80	DHRG 48	DHRG 80	●
V-W-X-Y	● 50-40	50	40	70	80	150	DHRG 70	DHRG 80	●

Esempio d'ordine: (DHMRD + 16-13) | Ordering example: (DHMRD + 16-13)
 Anelli di trascinamento non inclusi | Drive rings not included

● Nuove misure | New Measures

RECORD INDEX DRILL "DHMTR"

Accessori per punte modulari | Accessories for modular drills

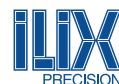

**ILIX
NORM**

DIN

A
02



06

► Cartucce interne ed esterne | Internal and external cartridges

	Cartuccia Int. Int. Cartridge	Cartuccia Ext. Ext. Cartridge	Gamma Range	Vite Cartuccia Cartridge scrow	Vite Inserto Screw insert	Inserto Insert	CI-CE
A	CI	CE	45-50	VTSM 4X10	VT 2.2X0.45	WCEX 030204..	●
B	CI	CE	50-55	VTSM 4X10	VT 2.2X0.45	WCEX 030204..	●
C	CI	CE	55-60	VTSM 5X12	VT 2.5X0.45	WCEX 040204..	●
D	CI	CE	60-65	VTSM 5X12	VT 3X0.5	WCEX 050308..	●
E	CI	CE	65-70	VTSM 5X12	VT 3X0.5	WCEX 050308..	●
F	CI	CE	70-75	VTSM 5X12	VT 3X0.5	WCEX 050308..	●
G	CI	CE	75-80	VTSM 6X12	VT 3.5X0.6	WCEX 06T308..	●
H	CI	CE	80-85	VTSM 6X14	VT 3.5X0.6	WCEX 06T308..	●
I	CI	CE	85-90	VTSM 6X16	VT 3.5X0.6	WCEX 06T308..	●
L	CI	CE	90-95	VTSM 6X16	VT 3.5X0.6	WCEX 06T308..	●
M	CI	CE	95-100	VTSM 6X16	VT 3.5X0.6	WCEX 06T308..	●

Esempio d'ordine: (CI + 45-50) | Ordering example: (CI + 45-50)

Inserto non incluso | Insert not included

NEW

**ILIX
NORM**

DIN



06

► Cartucce interne ed esterne | Internal and external cartridges

	Cartuccia Int. Int. Cartridge	Cartuccia Ext. Ext. Cartridge	Gamma Range	Vite Cartuccia Cartridge scrow	Vite Inserto Screw insert	Inserto Insert	CI-CE
N	CI	CE	100-105	VTSM 8X18	VT 3X0.5	WCEX 050308..	●
O	CI	CE	105-110	VTSM 8X18	VT 3.5X0.6	WCEX 06T308..	●
P	CI	CE	110-115	VTSM 8X18	VT 3.5X0.6	WCEX 06T308..	●
Q	CI	CE	115-120	VTSM 8X20	VT 3.5X0.6	WCEX 06T308..	●
R	CI	CE	120-125	VTSM 8X25	VT 3.5X0.6	WCEX 06T308..	●
S	CI	CE	125-130	VTSM 8X25	VT 3.5X0.6	WCEX 06T308..	●
T	CI	CE	● 130-135	VTSM 8X25	VT 3.5X0.6	WCEX 06T308..	●
U	CI	CE	● 135-140	VTSM 8X25	VT 3.5X0.6	WCEX 06T308..	●
V	CI	CE	● 140-150	VTSM 8X25	VT 4X0.7	WCEX 080408..	●
W	CI	CE	● 150-160	VTSM 8X25	VT 4X0.7	WCEX 080408..	●
X	CI	CE	● 160-170	VTSM 8X25	VT 4X0.7	WCEX 080408..	●
Y	CI	CE	● 170-180	VTSM 8X25	VT 4X0.7	WCEX 080408..	●

Esempio d'ordine: (CI + 100-105) | Ordering example: (CI + 100-105)

Inserto non incluso | Insert not included

● Nuove misure | New Measures

NEW

**ILIX
NORM**

DIN

► **PARTI DI RICAMBIO | SPARE PARTS (DHMTR)**



08

**Vite sicurezza
punta pilota**

Fixing Screw
for Pilot Drill

09

**Vite bloccaggio
punta pilota**

Clamping Bolt
for Pilot Drill

10

**Vite regolazione
assiale punta pilota**

Adjustment Screw
for Pilot Drill

11

**Vite bloccaggio
Punta**

Fixation
Screw

A	(GASM) 4X8	(GAFM) 6X10	(GARM) 6X10	(GABM) 8X12
B	(GASM) 4X8	(GAFM) 6X10	(GARM) 6X10	(GABM) 8X12
C	(GASM) 4X8	(GAFM) 8X12	(GARM) 8X15	(GABM) 8X12
D	(GASM) 5X8	(GAFM) 8X12	(GARM) 8X15	(GABM) 8X12
E	(GASM) 5X8	(GAFM) 8X12	(GARM) 8X15	(GABM) 8X12
F	(GASM) 5X8	(GAFM) 8X15	(GARM) 8X15	(GABM) 10X15
G	(GASM) 6X10	(GAFM) 10X20	(GARM) 10X16	(GABM) 10X15
H	(GASM) 6X10	(GAFM) 10X20	(GARM) 10X16	(GABM) 10X15
I	(GASM) 6X10	(GAFM) 10X20	(GARM) 10X18	(GABM) 12X18
L	(GASM) 6X10	(GAFM) 10X20	(GARM) 10X18	(GABM) 12X18
M	(GASM) 6X10	(GAFM) 10X20	(GARM) 10X18	(GABM) 12X18
N	(GASM) 6X10	(GAFM) 12X20	(GARM) 12X20	(GABM) 12X20
O	(GASM) 6X10	(GAFM) 12X20	(GARM) 12X20	(GABM) 12X20
P	(GASM) 6X10	(GAFM) 12X20	(GARM) 12X20	(GABM) 12X20
Q	(GASM) 6X10	(GAFM) 12X25	(GARM) 14X20	(GABM) 16X27
R	(GASM) 6X10	(GAFM) 14X25	(GARM) 14X20	(GABM) 16X27
S	(GASM) 6X10	(GAFM) 14X25	(GARM) 14X20	(GABM) 16X27
T	(GASM) 6X10	(GAFM) 14X25	(GARM) 14X20	(GABM) 16X27
U	(GASM) 6X10	(GAFM) 14X25	(GARM) 14X20	(GABM) 16X27
V	(GASM) 6X10	(GAFM) 14X25	(GARM) 14X20	(GABM) 16X27
W	(GASM) 6X10	(GAFM) 14X25	(GARM) 14X20	(GABM) 16X27
X	(GASM) 6X10	• (GAFM) 16X25	(GARM) 14X20	(GABM) 16X27
Y	(GASM) 6X10	• (GAFM) 16X25	(GARM) 14X20	(GABM) 16X27

• Nuove misure | New Measures

RECORD INDEX DRILL

Inserti in metallo duro integrale per punte a fissaggio meccanico
Solid carbide inserts for indexable drills

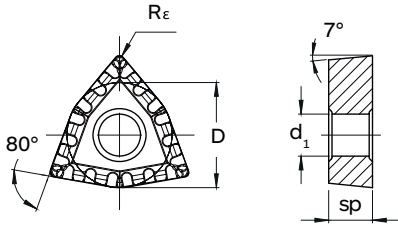

MATERIALE MATERIAL	
RIVESTIMENTO COATING	
DIREZIONE TAGLIO CUTTING DIRECTION	
GRUPPO MATERIALI MATERIAL GROUPS	P Acciai Steels
	M Acciai Inossidabili Stainless Steels
	K Ghise Cast Irons
	N Metalli non ferrosi Non-ferrous metals
	S Leghe resistenti al calore e Titanio HRSA and Titanium
	H Acciai Temprati Hardened Steels

M.D.I.-HM	M.D.I.-HM
-	-
↻	↻
P	P
-	-
-	-
-	-
-	-

Codice Inserto Insert Code	D	SP	Rε	d ₁	Vite inserto Insert screw	Chiave Torx Torx key	AGP 25	AGP 35
WCEX 050308-LC	7,94	3,18	0,8	3,5	VT 3X0.5	KY T8	●	●
WCEX 06T308-LC	9,55	3,97	0,8	4,1	VT 3.5X0.6	KY T15	●	●

Esempio d'ordine: (WCEX 050308-LC + AGP35) | Ordering example: (WCEX 050308-LC + AGP35)
Vite inserto e chiave torx non inclusa | Insert Screw and torx key not included

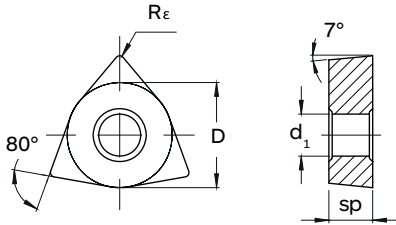

M.D.I.-HM	M.D.I.-HM
-	-
↻	↻
P	P
M	M
K	K
-	-
-	-
-	-

MATERIALE | MATERIAL
RIVESTIMENTO | COATING
DIREZIONE TAGLIO | CUTTING DIRECTION

GRUPPO MATERIALI
MATERIAL GROUPS

P | Acciai | Steels
M | Acciai Inossidabili | Stainless Steels
K | Ghise | Cast Irons
N | Metalli non ferrosi | Non-ferrous metals
S | Leghe resistenti al calore e Titanio | HRSA and Titanium
H | Acciai Temprati | Hardened Steels

Codice Inserto Insert Code	D	SP	Rε	d ₁	Vite inserto Insert screw	Chiave Torx Torx key	AGP 25	AGP 35
WCEX 030204-MC	4,76	1,98	0,4	2,00	VT 2.2X0.45	KY T7	●	●
WCEX 040204-MC	6,35	2,38	0,4	2,85	VT 2.5X0.45	KY T8	●	●
WCEX 050308-MC	7,94	3,18	0,8	3,50	VT 3X0.5	KY T8	●	●
WCEX 06T308-MC	9,55	3,97	0,8	4,10	VT 3.5X0.6	KY T15	●	●
WCEX 080408-MC	12,70	4,76	0,8	5,60	VT 4X0.7	KY T15	●	●

Esempio d'ordine: (WCEX 030204-MC + AGP35) | Ordering example: (WCEX 030204-MC + AGP35)
Vite inserto e chiave torx non inclusa | Insert Screw and torx key not included

RECORD INDEX DRILL

Inserti in metallo duro integrale per punte a fissaggio meccanico
Solid carbide inserts for indexable drills

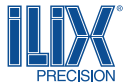

NEW

AGP 25

NEW

AGP 35

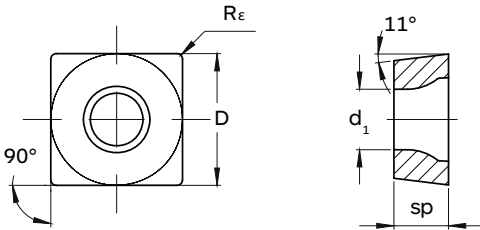

M.D.I.-HM **M.D.I.-HM**

TiAlN Futura TiAlN Futura



MATERIALE MATERIAL	
RIVESTIMENTO COATING	
DIREZIONE TAGLIO CUTTING DIRECTION	
GRUPPO MATERIALI MATERIAL GROUPS	P Acciai Steels
	M Acciai Inossidabili Stainless Steels
	K Ghise Cast Irons
	N Metalli non ferrosi Non-ferrous metals
	S Leghe resistenti al calore e Titanio HRSA and Titanium
	H Acciai Temprati Hardened Steels

P	P
M	M
K	K
-	-
-	-
-	-

Codice Inserto Insert Code	D	SP	Rε	d ₁	Vite inserto Insert screw	Chiave Torx Torx key	AGP 25	AGP 35
SPKX 060204-MC	6,00	2,38	0,4	2,55	VT 2.2X0.45	KY T7	●	●
SPKX 07T308-MC	7,94	3,97	0,8	2,85	VT 2.5X0.45X6.5	KY T8	●	●
SPKX 090408-MC	9,80	4,30	0,8	4,10	VT 3.5X0.6	KY T15	●	●
SPKX 110408-MC	11,50	4,80	0,8	4,40	VT 4X0.7X11	KY T15	●	●
SPKX 140512-MC	14,30	5,20	1,2	5,75	VT 5X0.8	KY T20	●	●

Esempio d'ordine: (SPKX 060204-MC + AGP35) | Ordering example: (SPKX 060204-MC + AGP35)
Vite inserto e chiave torx non inclusa | Insert Screw and torx key not included

A
02

NEW

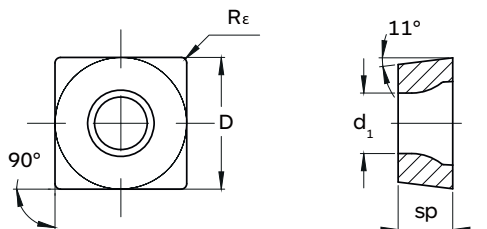

M.D.I.-HM

M.D.I.-HM

MATERIALE | MATERIAL

RIVESTIMENTO | COATING

DIREZIONE TAGLIO | CUTTING DIRECTION

-

TiN



GRUPPO MATERIALI
MATERIAL GROUPS

P | Acciai | Steels

M | Acciai Inossidabili | Stainless Steels

K | Ghise | Cast Irons

N | Metalli non ferrosi | Non-ferrous metals

S | Leghe resistenti al calore e Titanio | HRSA and Titanium

H | Acciai Temprati | Hardened Steels

-

P

-

M

-

K

N

-

-

-

-

-

Codice Inserto Insert Code	D	SP	Rε	d ₁	Vite inserto Insert screw	Chiave Torx Torx key	AGN 010	AGU 30
SPHX 060204-LN	6,00	2,38	0,4	2,55	VT 2.2X0.45	KY T7	●	-
SPKX 060204-MC	6,00	2,38	0,4	2,55	VT 2.2X0.45	KY T7	-	●
SPKX 07T308-MC	7,94	3,97	0,8	2,85	VT 2.5X0.45X6.5	KY T8	-	●
SPKX 090408-MC	9,80	4,30	0,8	4,10	VT 3.5X0.6	KY T15	-	●
SPKX 110408-MC	11,50	4,80	0,8	4,40	VT 4X0.7X11	KY T15	-	●
SPKX 140512-MC	14,30	5,20	1,2	5,75	VT 5X0.8	KY T20	-	●

Esempio d'ordine: (SPKX 060204-MC + AGU30) | Ordering example: (SPKX 060204-MC + AGU30)
Vite inserto e chiave torx non inclusa | Insert Screw and torx key not included

► DESCRIZIONE QUALITÀ INSERTI | INSERT GRADE DESCRIPTION

PVD			
Qualità Grade	Gruppo Materiali Materials group	Descrizione Description	Rivestimento Coating
AGP25	P 10-35	Qualità rivestita per una forte resistenza all'usura substrato per lavorazioni generiche ad elevata velocità di taglio. Coated grade over a tough wear resistance substrate for general purpose machining.	
	M 10-25		
	K 10-30		
AGP35	P 20-40	Qualità rivestita adatta per applicazioni con condizioni di instabilità. Ottima soluzione per applicazioni a media velocità di taglio. Grade suitable for applications with instability conditions. Excellent solution for medium cutting speed applications.	
	M 20-30		
	K 20-40		
AGU30	P 20-40	Qualità simile a AGP35 con rivestimento PVD multi strato che offre una migliore resistenza all'usura per lavorazioni generiche ad elevate velocità di taglio. Similar quality to AGP35 with multi-layer PVD coating offering improved wear resistance for general machining at high cutting speeds.	
	M 20-30		
	K 20-40		

NON RIVESTITO | UNCOATED

Qualità Grade	Gruppo Materiali Materials group	Descrizione Description	Rivestimento Coating
AGN010	N 01-20	Qualità micrograna in metallo duro non rivestito che unisce una buona resistenza all'usura abrasiva e tenacità. Uncoated carbide micro-grain grade combining a good abrasive wear resistance and toughness.	

► QUALITÀ CONSIGLIATE PER OTTIMIZZARE IL PROCESSO DI FORATURA GRADES RECOMMENDATION FOR DRILLING SYSTEMS



Note | Note:

Questi differenti posizionamenti potrebbero garantire risultati migliori nelle forature di acciai alto legati, acciai inossidabili e leghe resistenti al calore.
Different placements would give better results if applied to machining high alloy steels, stainless steels and HRSA materials.

► **MODALITÀ MONTAGGIO INSERTI | INSERT MOUNTING MODE**

GTR3D-GTR4D

 Vite Insetto Insert Screw (x2)	 Chiave Torx Torx key
--	--

GSQ3D-GTR4D

 Vite Insetto Insert Screw (x2)	 Chiave Torx Torx key
---	--

DHTR Ø25-40

 Vite Insetto Insert Screw (x2)	 Chiave Torx Torx key
--	--

DHTR Ø41-45

 Vite Insetto Insert Screw (x2)	 Vite Cartuccia Cartridge Screw (x2)	 Chiave Torx Torx key
---	--	--

DHMTR - Versione a doppia cartuccia | Double cartridge version

 Vite Insetto (x4) Insert Screw	 Cartuccia (Int.-Ext) (x2) Cartridge (Int.-Ext)	 Vite Cartuccia (x2) Cartridge Screw	 Chiave Torx Torx key
---	---	--	--



► REGOLAZIONE PUNTA PILOTA | PILOT DRILL ADJUSTMENT

DHTR	
d_1	h (mm)
18-24	2,5
25-30	3,0
31-39	4,0
40-45	4,5

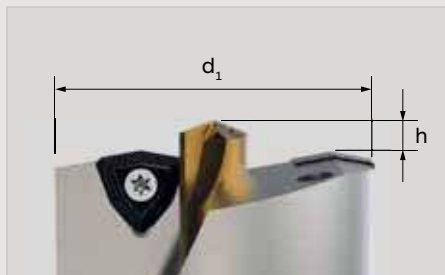

DHMTR			
d_1	2xD fino a 4xD 2xD to 4xD	4xD fino a 6xD 4xD to 6xD	>6xD
	h (mm)	h (mm)	h (mm)
45-55	4.0	4.2	4.4
55-75	5.4	5.6	5.8
75-100	6.5	6.8	7.1
100-120	7.7	8.1	8.5
120-170	9.9	10.3	10.7
170-180	12.2	12.6	13.0

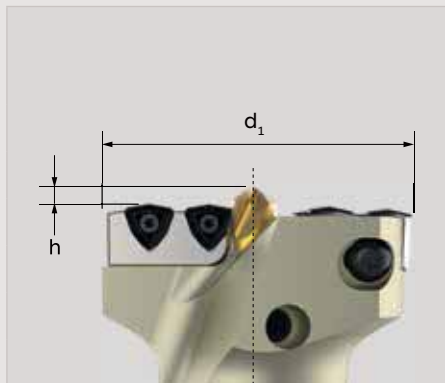

► MODIFICA DEL DIAMETRO DELLA PUNTA DHMTR TRAMITE REGOLAZIONE DELLA CARTUCCIA EST. DHMTR DRILL DIAMETER CHANGE BY OUTER CARTRIDGE ADJUSTMENT

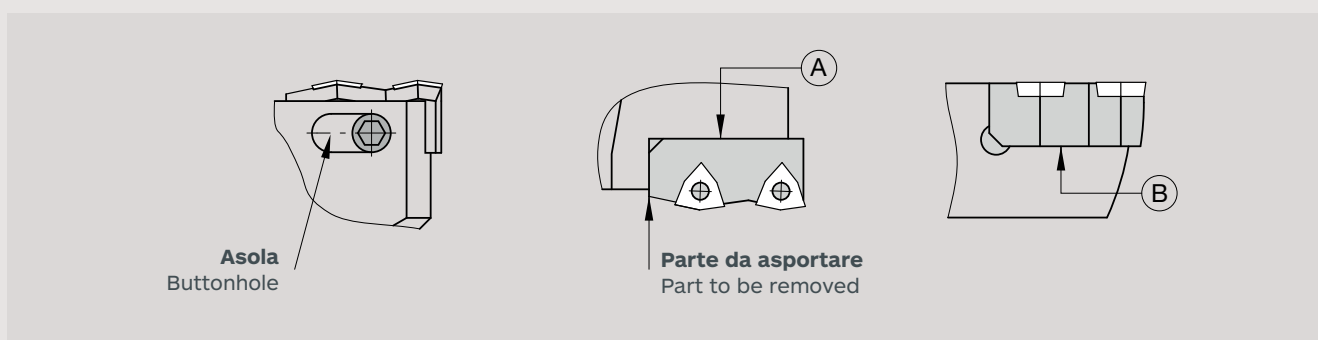

ITA

- Le cartucce esterne vengono fornite al massimo della dimensione scelta.
- Le cartucce esterne sono regolabili e possono essere adattate per diametri minori asportando il materiale in eccesso.
- Le cartucce esterne devono essere lavorate ad angolo retto rispetto alle superfici d'appoggio A e B.

ENG

- External cartridges are supplied up to the maximum chosen size.
- Adjustable outer cartridges adapted to minor diameter by removing radial material.
- Outer cartridges shorten at 90° to the face contact A and B

**A
02**

► **TOLLERANZA DEL FORO E DIMENSIONE MASSIMA DEL FORO CON SCOSTAMENTO RADIALE**
HOLE TOLERANCE AND MAXIMUM HOLE SIZE WITH RADIAL OFFSET

GSQ3D

Ø Punta Drill	Scostamento radiale Radial Adjust	Diametro massimo del foro Max Hole D
16	0.50	17.0
17	0.50	18.0
18	0.50	19.0
19	0.50	20.0
20	0.50	21.0
21	0.25	21.5
22	0.50	23.0
23	0.50	24.0
24	0.50	25.0
25	0.50	26.0
26	0.25	26.5
27	0.25	27.5
28	0.50	29.0
29	0.50	30.0
30	0.50	31.0
31	0.25	31.5
32	0.25	32.5
33	0.25	33.5
34	0.50	35.0
35	0.50	36.0
36	0.50	37.0
37	0.50	38.0
38	0.50	39.0
39	0.50	40.0
40	0.25	40.5
41	0.25	41.5
42	0.50	43.0
43	0.50	44.0
44	0.50	45.0
45	0.50	46.0
46	0.50	47.0
47	0.50	48.0
48	0.25	48.5
49	0.25	49.5
50	0.25	50.5



► **TOLLERANZA DEL FORO E DIMENSIONE MASSIMA DEL FORO CON SCOSTAMENTO RADIALE**
HOLE TOLERANCE AND MAXIMUM HOLE SIZE WITH RADIAL OFFSET

GSQ4D

Ø Punta Drill	Scostamento radiale Radial Adjust	Diametro massimo del foro Max Hole D
16	0.50	17.0
17	0.50	18.0
18	0.50	19.0
19	0.50	20.0
20	0.50	21.0
21	0.25	21.5
22	0.50	23.0
23	0.50	24.0
24	0.50	25.0
25	0.50	26.0
26	0.25	26.5
27	0.25	27.5
28	0.50	29.0
29	0.50	30.0
30	0.50	31.0
31	0.25	31.5
32	0.25	32.5
33	0.25	33.5
34	0.50	35.0
35	0.50	36.0
36	0.50	37.0
37	0.50	38.0
38	0.50	39.0
39	0.50	40.0
40	0.25	40.5
41	0.25	41.5
42	0.50	43.0
43	0.50	44.0
44	0.50	45.0
45	0.50	46.0
46	0.50	47.0
47	0.50	48.0
48	0.25	48.5
49	0.25	49.5
50	0.25	50.5

A
02



► POTENZA DI FORATURA NECESSARIA | DRILLING POWER REQUIREMENTS

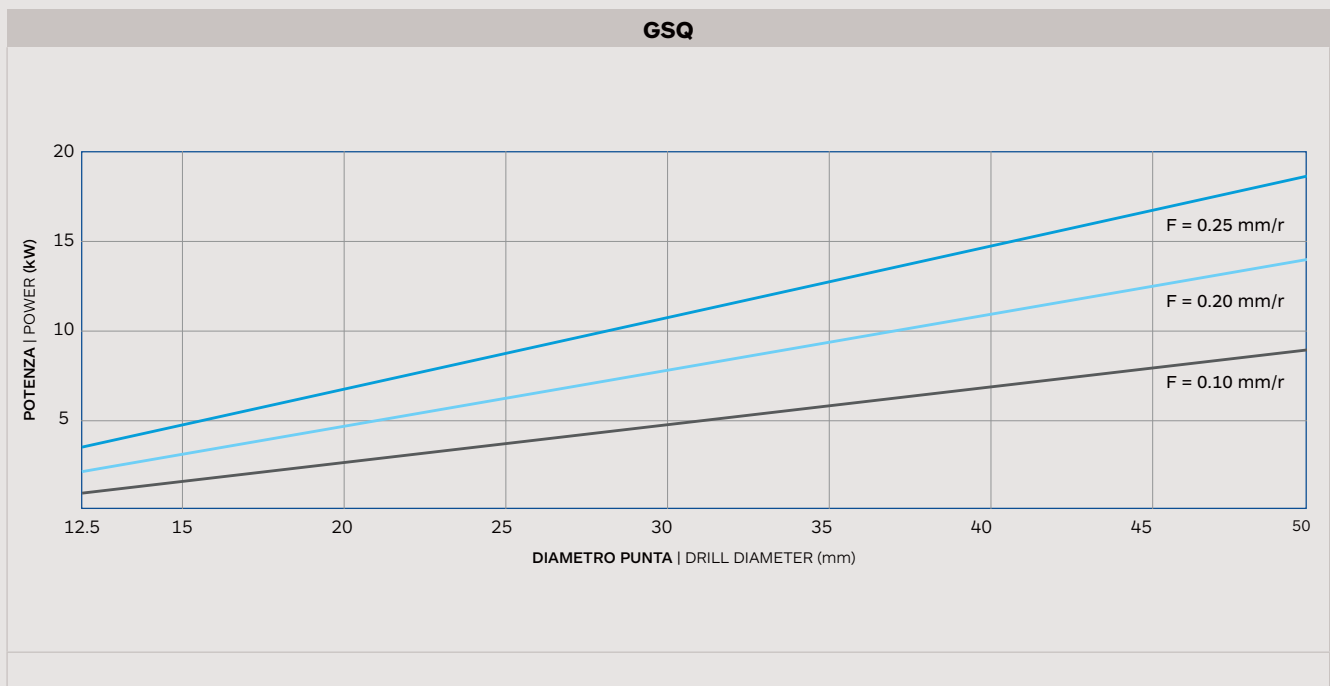
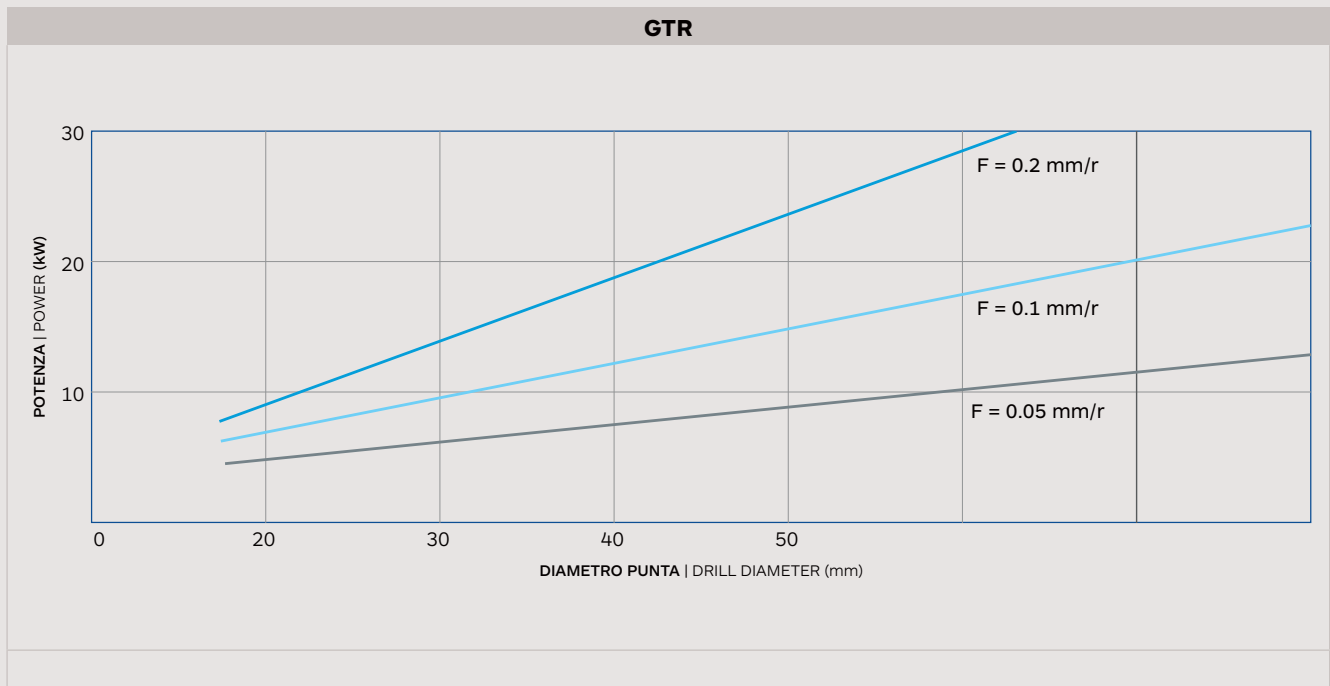

ITA

- Questa tabella si basa su forature di acciai con durezza comprese tra 200-250HB e velocità di taglio di 100 m/min.
- Per la ghisa grigia o lamellare la potenza effettiva richiesta è inferiore di circa il 30%.

ENG

- This chart is based on machining experiences using steels with a hardness of 200-250HB and cutting speed of 100m/min.
- For grey or lamellar cast iron the effective power requirement is around 30% lower.



► POTENZA DI FORATURA NECESSARIA | DRILLING POWER REQUIREMENTS

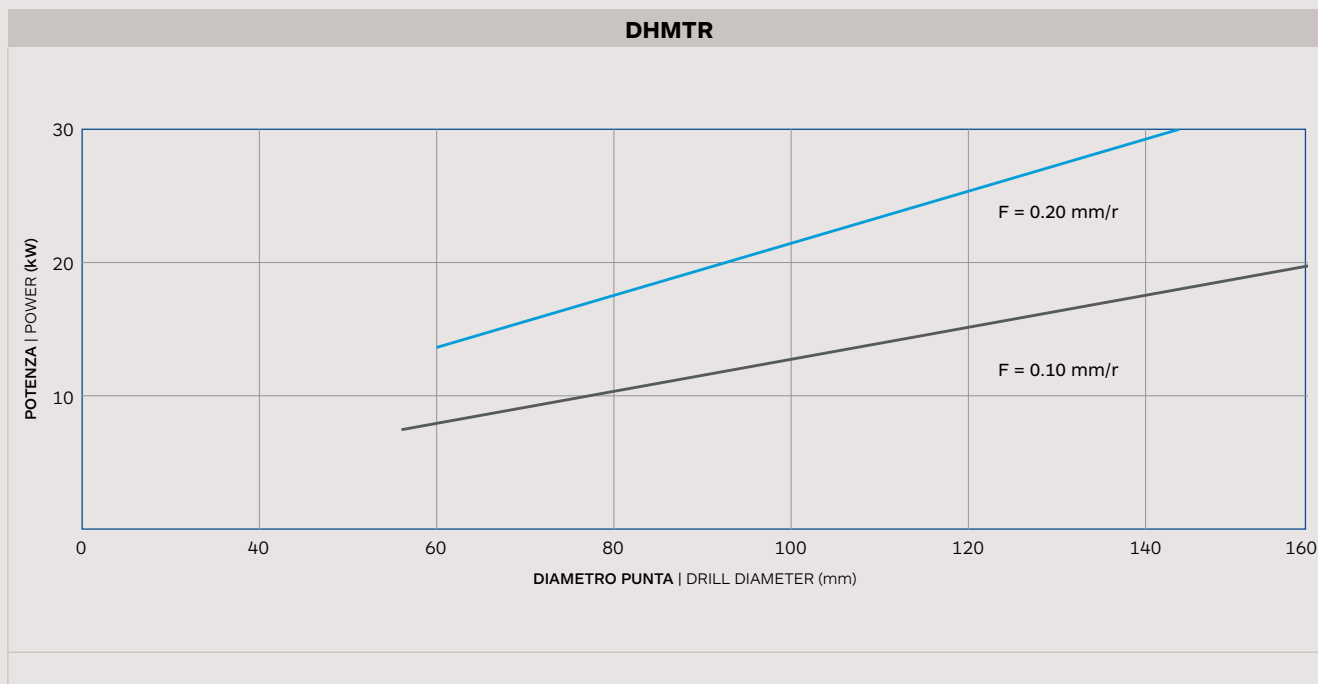
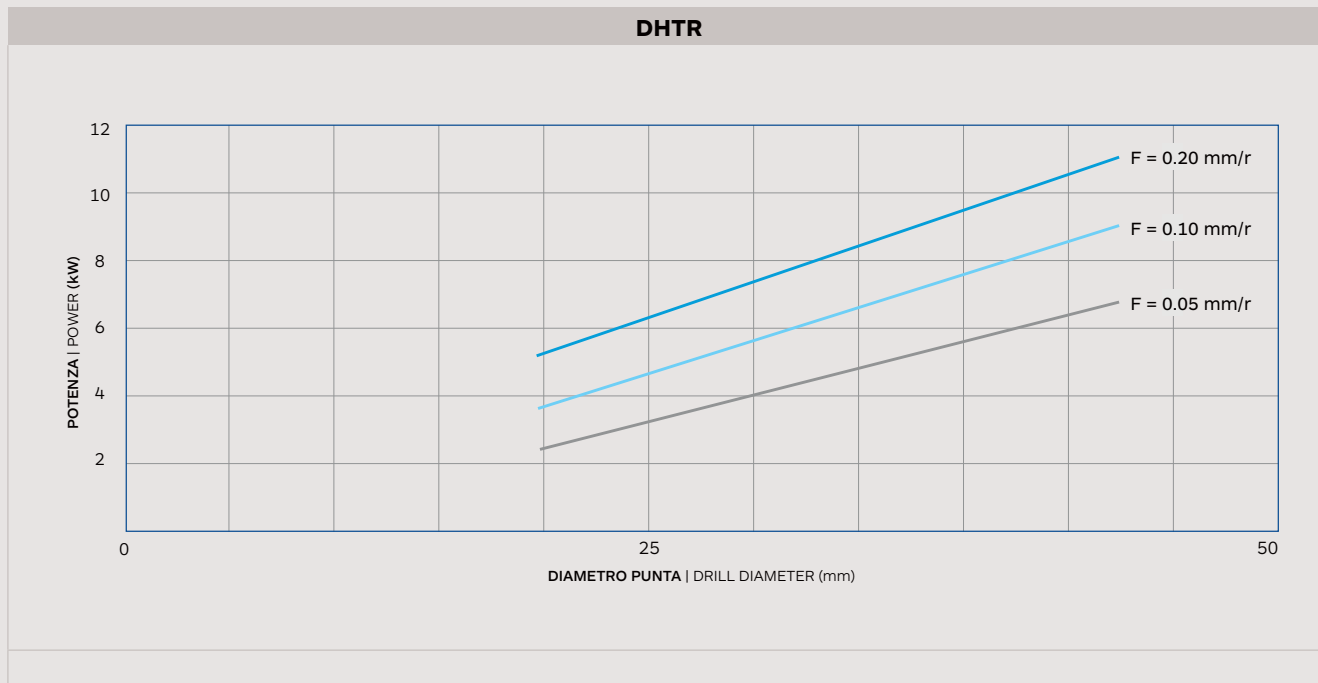

ITA

- Questa tabella si basa su forature di acciai con durezza comprese tra 200-250HB e velocità di taglio di 100 m/min.
- Per la ghisa grigia o lamellare la potenza effettiva richiesta è inferiore di circa il 30%.

ENG

- This chart is based on machining experiences using steels with a hardness of 200-250HB and cutting speed of 100m/min.
- For grey or lamellar cast iron the effective power requirement is around 30% lower.

A
02



► TABELLA APPLICAZIONE REFRIGERANTE | COOLANT APPLICATION CHART

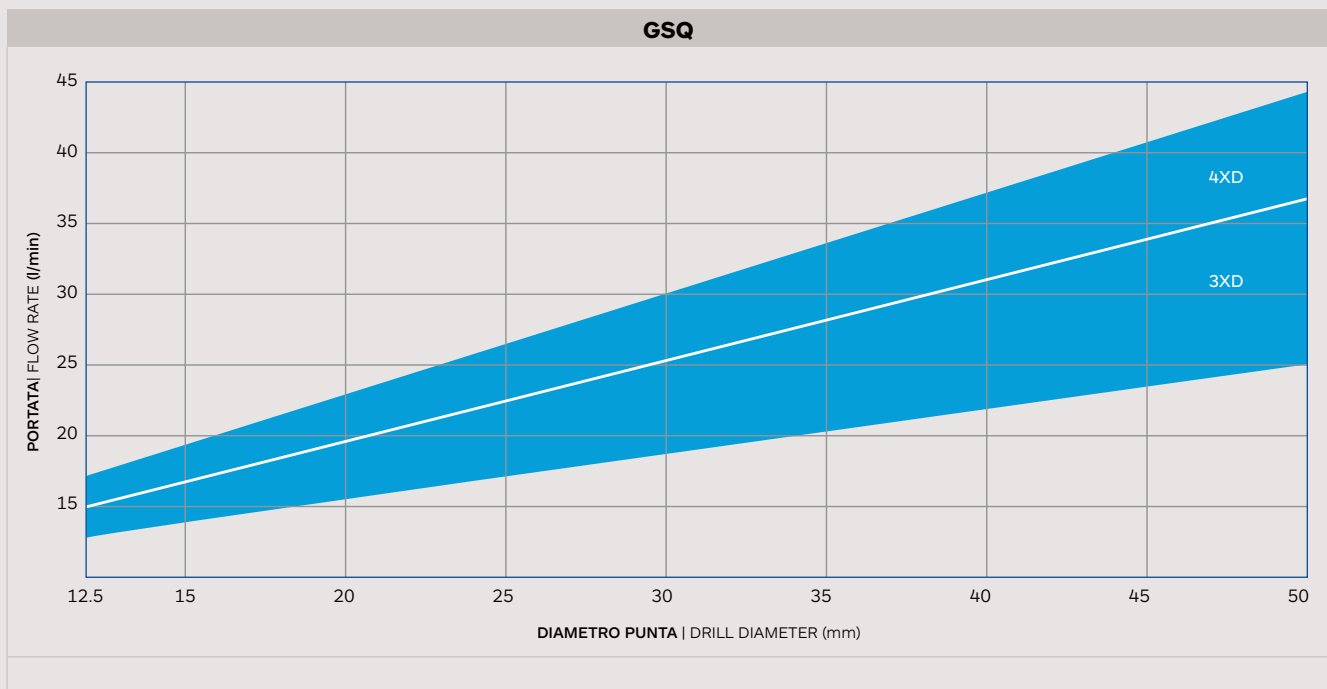
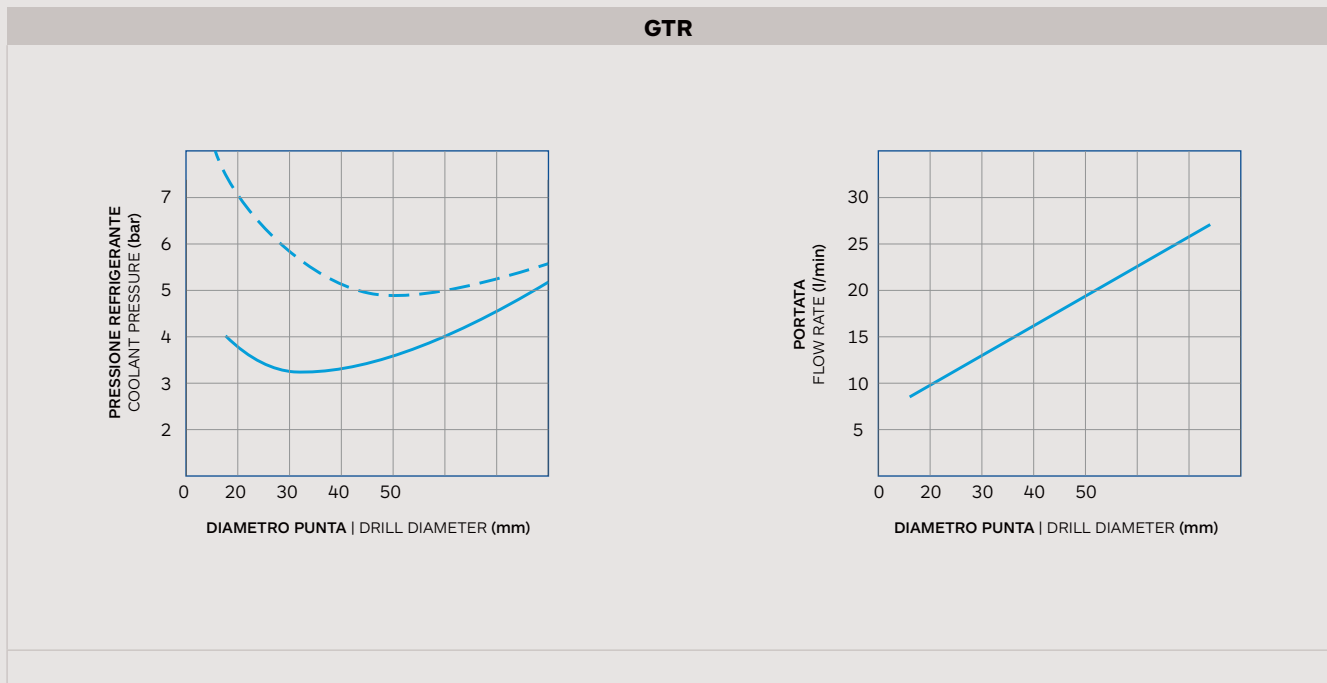

ITA

- Questa tabella si basa su forature di acciai con durezza comprese tra 200-250HB e velocità di taglio di 100 m/min.
- Per la ghisa grigia o lamellare la potenza effettiva richiesta è inferiore di circa il 30%.

ENG

- This chart is based on machining experiences using steels with a hardness of 200-250HB and cutting speed of 100m/min.
- For grey or lamellar cast iron the effective power requirement is around 30% lower.





► TABELLA APPLICAZIONE REFRIGERANTE | COOLANT APPLICATION CHART

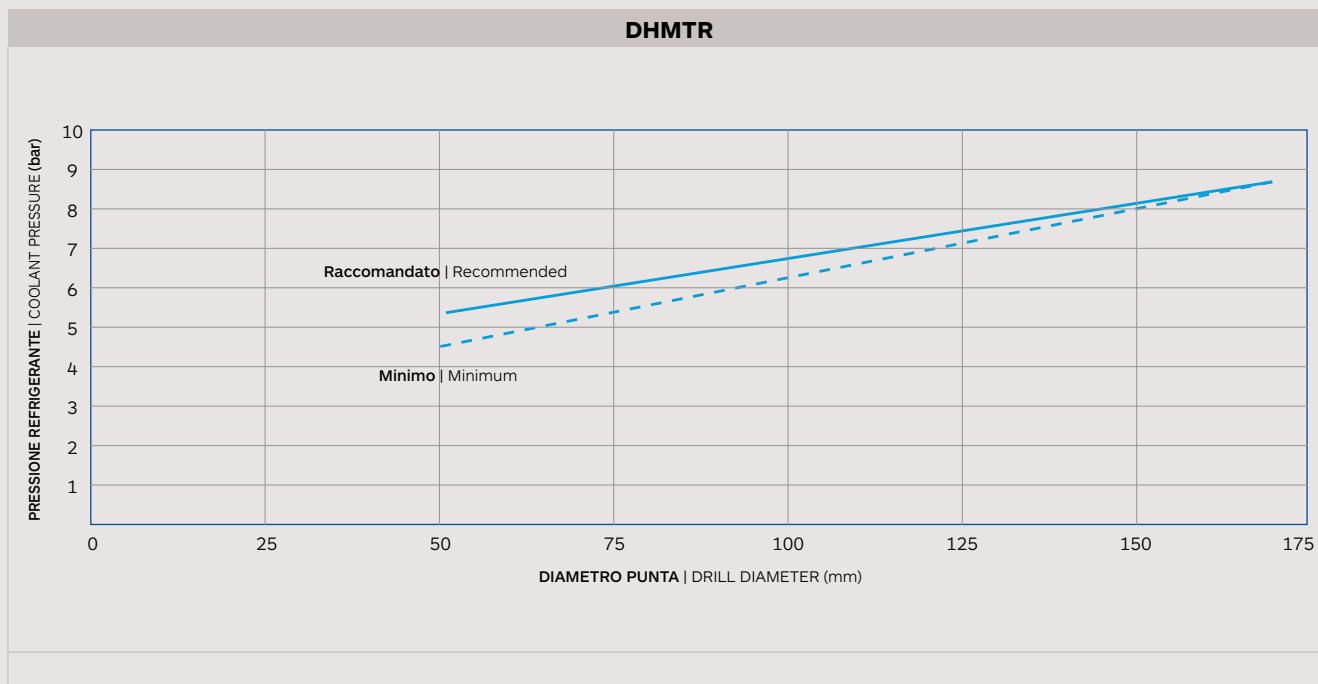
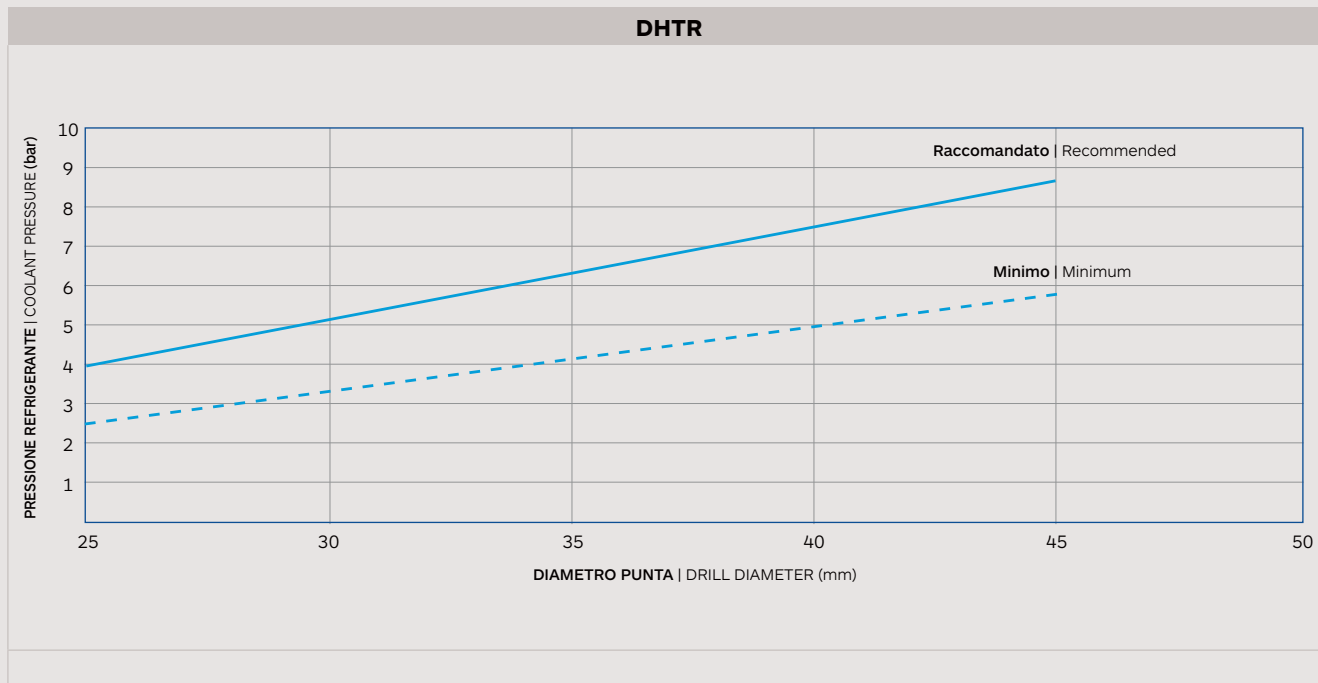

ITA

- Questa tabella si basa su forature di acciai con durezza comprese tra 200-250HB e velocità di taglio di 100 m/min.
- Per la ghisa grigia o lamellare la potenza effettiva richiesta è inferiore di circa il 30%.

ENG

- This chart is based on machining experiences using steels with a hardness of 200-250HB and cutting speed of 100m/min.
- For grey or lamellar cast iron the effective power requirement is around 30% lower.



► RISOLUZIONE DEI PROBLEMI | TROUBLESHOOTING

GTR-GSQ

Problema Problem	Soluzioni	Corrective Action
	<p>Sui torni:</p> <ul style="list-style-type: none"> • Controllare l'allineamento della macchina. • Controllare il sistema di serraggio. Se non fosse possibile migliorarlo, ridurre l'avanzamento del 30%. • Utilizzare una qualità più resistente di metallo duro. <p>CONSIGLIO: Le due qualità disponibili possono essere combinate sul medesimo corpo punta per ottenere prestazioni ottimali.</p> <p>Esempio: Utilizzare la qualità AGP35 nella sede centrale e AGP25 in quella esterna.</p>	<p>On Lathes:</p> <ul style="list-style-type: none"> • Check machine alignment. • Check the clamping accuracy. If tool clamping cannot be improved reduce feed by 30%. • User tougher carbide grade. <p>TIP: The two available grades can be combined on the same body for optimum performance.</p> <p>Example: Use grade AGP35 in the inside pocket with AGP25 in the outside pocket.</p>
Fessurazione del tagliente interno Inner cutting edge cracking		
	<ul style="list-style-type: none"> • Aumentare la pressione e la portata del refrigerante (il refrigerante aiuta l'evacuazione dei trucioli così come il raffreddamento dei taglienti). • Ottimizzare il controllo del truciolo per una determinata applicazione. 	<ul style="list-style-type: none"> • Increase coolant pressure and volume (coolant helps support chip evacuation as well as cooling the cutting edges). • Optimize chip control for a given application.
Evacuazione del truciolo non ottimale Chip evacuation not optimal		
	<ul style="list-style-type: none"> • Aumentare la pressione ed la portata del refrigerante. • Utilizzare una qualità più resistente all'usura. 	<ul style="list-style-type: none"> • Increase coolant pressure and volume. • Use a more wear – resistant grade.
Usura eccessiva dell'inserto Excessive insert wear		
	<ul style="list-style-type: none"> • Aumentare la pressione ed la portata del refrigerante. • Controllare la precisione di bloccaggio (utensile e pezzo) per eventuali miglioramenti. <p>CONSIGLIO:</p> <ul style="list-style-type: none"> • Utilizzare una velocità di taglio maggiore con un avanzamento minore per produrre una migliore qualità del foro. 	<ul style="list-style-type: none"> • Increase coolant pressure and volume. • Check clamping accuracy (tool and workpiece) for possible improvement. <p>TIP:</p> <ul style="list-style-type: none"> • Use higher cutting speed with lighter feed to produce better hole quality.
Scarsa qualità del foro Poor drill hole quality		







► RISOLUZIONE DEI PROBLEMI | TROUBLESHOOTING

DHTR		
Problema Problem	Soluzioni	Corrective Action
	Sui torni: <ul style="list-style-type: none"> • Verificare che l'utensile sia centrato correttamente. • Controllare la precisione di bloccaggio (utensile e pezzo). • Ridurre la velocità di taglio 	On Lathes: <ul style="list-style-type: none"> • Verify that the tool is centered correctly. • Check clamping accuracy (tool and work piece). • Reduce cutting speed
Fessurazione della punta pilota Pilot drill cracking		
	<ul style="list-style-type: none"> • Utilizzare una qualità più resistente di metallo duro. • Ridurre l'avanzamento del 20%. • Controllare la precisione di bloccaggio (utensile e pezzo) per eventuali miglioramenti. 	<ul style="list-style-type: none"> • Use tougher carbide grade. • Reduce feed by 20%. • Check clamping accuracy (tool and workpiece) for possible improvement.
Fessurazione dell'inserto interno Inner insert cracking		
	<ul style="list-style-type: none"> • Utilizzare una qualità più resistente di metallo duro e/o una geometria dell'inserto più resistente. • Ridurre la velocità di taglio del 20% • Controllare la precisione di bloccaggio (utensile e pezzo) per eventuali miglioramenti. 	<ul style="list-style-type: none"> • Use tougher carbide grade and / or stronger insert geometry. • Reduce cutting speed by 20% • Check clamping accuracy (tool and workpiece) for possible improvement.
Fessurazione dell'inserto esterno Outer insert cracking		
	<ul style="list-style-type: none"> • Utilizzare una punta pilota in metallo duro rivestita. • Aumentare la pressione e portata del refrigerante. • Ridurre la velocità di taglio del 20%. 	<ul style="list-style-type: none"> • Use coated carbide pilot drill. • Increase coolant pressure and volume. • Reduce cutting speed by 20%.
Usura estesa della punta pilota Extensive pilot drill wear		
	Sui torni: <ul style="list-style-type: none"> • Utilizzare una qualità di metallo duro più resistente all'usura. • Aumentare la pressione ed il volume del refrigerante. • Ridurre la velocità di taglio del 20%. 	On Lathes: <ul style="list-style-type: none"> • Use a more wear-resistant carbide grade. • Increase coolant pressure and volume. • Reduce cutting speed by 20%.
Usura eccessiva dell'inserto Excessive insert wear		
	<ul style="list-style-type: none"> • Ottimizzare il controllo del truciolo per una determinata applicazione. • Aumentare la velocità di taglio del 20%, ridurre l'avanzamento del 20%. 	<ul style="list-style-type: none"> • Optimize chip control for given application. • Increase cutting speed by 20%, reduce feed by 20%.
Rottura del truciolo non ottimale Chip breaking not optimal		
	<ul style="list-style-type: none"> • Aumentare il volume e la pressione del refrigerante. • Aumentare la velocità di taglio del 20%. 	<ul style="list-style-type: none"> • Increase coolant pressure and volume. • Increase cutting speed by 20%.
Evacuazione del truciolo non ottimale, Scarsa qualità del foro. Chip evacuation not optimal, Poor drill hole quality		

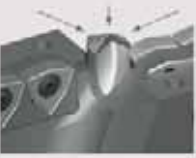

► RISOLUZIONE DEI PROBLEMI | TROUBLESHOOTING

DHMTR

Problema Problem	Soluzioni	Corrective Action
	Sui torni: <ul style="list-style-type: none"> • Verificare che l'utensile sia centrato correttamente. • Controllare la precisione di bloccaggio (dell'utensile e del pezzo). 	On Lathes: <ul style="list-style-type: none"> • Verify that the tool is centered correctly. • Check clamping accuracy (tool and workpiece).
Fessurazione della punta pilota Pilot drill cracking		
	<ul style="list-style-type: none"> • Utilizzare una qualità di metallo duro più resistente. • Controllare la precisione di bloccaggio (utensile e pezzo) per possibili miglioramenti. • Verificare la percentuale dell'olio dell'emulsione. 	<ul style="list-style-type: none"> • Use tougher carbide grade. • Check clamping accuracy (tool and workpiece) for possible improvement. • Check the percentage of oil in the emulsion.
Fessurazione dell'inserto Insert cracking		
	<ul style="list-style-type: none"> • Utilizzare una punta pilota rivestita. • Aumentare la pressione ed il volume di refrigerante. • Ridurre la velocità di taglio del 20%. • Utilizzare una qualità di metallo duro resistente all'usura. 	<ul style="list-style-type: none"> • Use coated pilot drill. • Increase coolant pressure and volume. • Reduce cutting speed by 20% • Use wear and resistant carbide grade.
Usura eccessiva dell'inserto Excessive insert wear		
	<ul style="list-style-type: none"> • Ottimizzare il controllo del truciolo per una determinata applicazione. • Aumentare la velocità di taglio del 20%, ridurre l'avanzamento del 20%. 	<ul style="list-style-type: none"> • Optimize chip control for given application. • Increase cutting speed by 20%, reduce feed by 20%.
Rottura del truciolo non ottimale Chip breaking not optimal		
	<ul style="list-style-type: none"> • Aumentare la pressione e la portata di refrigerante. • Aumentare la velocità di taglio del 20%. 	<ul style="list-style-type: none"> • Increase coolant pressure and volume. • Increase cutting speed by 20%.
Evacuazione del truciolo non ottimale, scarsa qualità del foro. Chip evacuation not optimal, Poor drill hole quality		

PUNTE A FISSAGGIO MECCANICO
INDEXABLE DRILLS

A
02



A.02.03

Parametri di taglio
Cutting data

**A
02**

Famiglia prodotto Family product		Codice cuspidi Inserts Code	Acciaio debolmente legato Low-Alloyed Steel <800 N/mm ²	Acciaio mediamente legato Medium-Alloyed Steel 700/1000 N/mm ²	Acciaio fortemente legato High-Alloyed Steel 1000/1300 N/mm ²	Acciaio inossidabile Martensitico/Ferritico Stainless steel Martensitic/Ferritic	Acciaio inossidabile Austenitico Stainless steel Austenitic	Ghisa grigia Grey cast iron	Ghisa sferoidale Nodular cast iron
Gruppo Materiali Materials Group			P1	P2	P3	M1	M2	K1	K2

			V _c	f	V _c	f	V _c	f	V _c	f	V _c	f	V _c	f	V _c	f
RECORD AG DRILL 501D		50PHTF	125	7	85	6	60	5	45	3	30	3	110	6	85	6
		50GMTF	130	7	90	6	65	5	-	-	-	-	-	-	-	-
		50DMTX	-	-	-	-	-	-	50	3	40	3	-	-	-	-
		50SMTL	-	-	-	-	-	-	-	-	-	-	-	-	-	-
		50CMTF	-	-	-	-	-	-	-	-	-	-	120	6	90	6
RECORD AG DRILL 503D		50GMTF	130	7	90	6	65	5	-	-	-	-	-	-	-	-
		50DMTX	-	-	-	-	-	-	50	3	40	3	-	-	-	-
		50SMTL	-	-	-	-	-	-	-	-	-	-	-	-	-	-
		50CMTF	-	-	-	-	-	-	-	-	-	-	120	6	90	6
RECORD AG DRILL 505D		50GMTF	125	7	85	6	55	5	-	-	-	-	-	-	-	-
		50DMTX	-	-	-	-	-	-	50	3	35	3	-	-	-	-
		50SMTL	-	-	-	-	-	-	-	-	-	-	-	-	-	-
		50CMTF	-	-	-	-	-	-	-	-	-	-	120	6	80	6

 V_c: Velocità di taglio (m/min) | Cutting speed (m/min) f: Numero di avanzamento | Feed number

Avanzamento f_n (mm/g) per RECORD AG DRILL 500 | Feed f_n (mm/rev) for RECORD AG DRILL 500

		Ø12	Ø16	Ø20
Numero avanzamento Feed Number	1	0,080	0,100	0,130
	2	0,100	0,130	0,160
	3	0,130	0,160	0,200
	4	0,160	0,200	0,260
	5	0,200	0,260	0,320
	6	0,260	0,320	0,400
	7	0,320	0,400	0,500
	8	0,400	0,500	0,650

Esempio della scelta dei dati di lavoro: 503D Ø 20 (50GMTF) | Gruppo materiale P1 | V_c = 130 m/min | f_n = 0,500 mm/giro (coefficiente f=7)
Cutting data example: 503D Ø 20 (50GMTF) | Material group P1 | V_c = 130 m/min | f_n = 0,500 mm/rev (coefficient f=7)

PARAMETRI DI TAGLIO | CUTTING DATA

Punte a fissaggio meccanico | Indexable drills

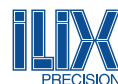

Alluminio e leghe di Alluminio Aluminum and Aluminum alloys	Materiali non ferrosi Non ferrous materials	Titanio e leghe di Titanio Titanium and Titanium alloys	HRSA Leghe resistenti al calore Heat resistant alloys	Acciai temprati Hardened steels 38/48 HRC	Acciai temprati Hardened steels 48/58 HRC	Acciai temprati Hardened steels 58/68 HRC	Codice cuspidi Inserts Code		Pagina catalogo Catalogue page
N1	N2	S1	S2	H1	H2	H3	Gruppo Materiali Materials Group		

V _c	f	V _c	f	V _c	f	V _c	f	V _c	f	V _c	f	V _c	f				
150	7	70	6	30	2	20	2	20	2	-	-	-	-	50PHTF			143
-	-	-	-	-	-	25	2	-	-	-	-	-	-	50GMTF			
-	-	-	-	35	2	25	2	-	-	-	-	-	-	50DMTX			
170	7	80	6	-	-	-	-	-	-	-	-	-	-	50SMTL			
-	-	-	-	-	-	-	-	-	-	-	-	-	-	50CMTF			144
-	-	-	-	-	-	25	2	-	-	-	-	-	-	50GMTF			
-	-	-	-	35	2	25	2	-	-	-	-	-	-	50DMTX			
170	7	80	6	-	-	-	-	-	-	-	-	-	-	50SMTL			
-	-	-	-	-	-	-	-	-	-	-	-	-	-	50CMTF			145
-	-	-	-	-	-	20	2	-	-	-	-	-	-	50GMTF			
-	-	-	-	35	2	25	2	-	-	-	-	-	-	50DMTX			
150	7	70	6	-	-	-	-	-	-	-	-	-	-	50SMTL			
-	-	-	-	-	-	-	-	-	-	-	-	-	-	50CMTF			

Ø 26	Ø 32	Ø 40		Numero avanzamento Feed Number
0,160	0,180	0,200	1	
0,200	0,220	0,260	2	
0,260	0,290	0,320	3	
0,320	0,340	0,400	4	
0,400	0,420	0,500	5	
0,500	0,550	0,650	6	
0,650	0,700	0,800	7	
0,800	0,900	1,000	8	

► I parametri di taglio indicati in tabella sono da considerarsi validi in condizioni macchina/pezzo ottimali
The cutting parameters shown in the table have to be considered valid in optimal machine/workpiece conditions

**A
02**

Famiglia prodotto Family product		Codice cuspidi Inserts Code	Acciaio debolmente legato Low-Alloyed Steel <800 N/mm ²	Acciaio mediamente legato Medium-Alloyed Steel 700/1000 N/mm ²	Acciaio fortemente legato High-Alloyed Steel 1000/1300 N/mm ²	Acciaio inossidabile Martensitico/Ferritico Stainless steel Martensitic/Ferritic	Acciaio inossidabile Austenitico Stainless steel Austenitic	Ghisa grigia Grey cast iron	Ghisa sferoidale Nodular cast iron
Gruppo Materiali Materials Group			P1	P2	P3	M1	M2	K1	K2

				V _c	f	V _c	f	V _c	f	V _c	f	V _c	f	V _c	f	V _c	f
RECORD AG DRILL 507D			50GMTF	120	5	80	4	50	3	-	-	-	-	-	-	-	-
			50DMTX	-	-	-	-	-	-	50	2	35	2	-	-	-	-
			50SMTL	-	-	-	-	-	-	-	-	-	-	-	-	-	-
			50CMTF	-	-	-	-	-	-	-	-	-	120	6	80	5	-
RECORD AG DRILL 510D			50GMTF	100	5	70	4	50	3	-	-	-	-	-	-	-	-
			50DMTX	-	-	-	-	-	-	50	2	35	2	-	-	-	-
			50SMTL	-	-	-	-	-	-	-	-	-	-	-	-	-	-
			50CMTF	-	-	-	-	-	-	-	-	-	100	6	80	5	-

V_c: Velocità di taglio (m/min) | Cutting speed (m/min) f: Numero di avanzamento | Feed number

Avanzamento f_n (mm/g) per RECORD AG DRILL 500 | Feed f_n (mm/rev) for RECORD AG DRILL 500

		Ø12	Ø16	Ø20
Numero avanzamento Feed Number	1	0,080	0,100	0,130
	2	0,100	0,130	0,160
	3	0,130	0,160	0,200
	4	0,160	0,200	0,260
	5	0,200	0,260	0,320
	6	0,260	0,320	0,400
	7	0,320	0,400	0,500
	8	0,400	0,500	0,650

Esempio della scelta dei dati di lavoro: 507D Ø 20 (50GMTF) | Gruppo materiale **P1** | V_c = 120 m/min | f_n = **0,320 mm/giro** (coefficiente f=5)
Cutting data example: 507D Ø 20 (50GMTF) | Material group **P1** | V_c = 120 m/min | f_n = **0,320 mm/rev** (coefficient f=5)

PARAMETRI DI TAGLIO | CUTTING DATA

Punte a fissaggio meccanico | Indexable drills

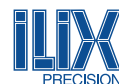

Alluminio e leghe di Alluminio Aluminum and Aluminum alloys	Materiali non ferrosi Non ferrous materials	Titanio e leghe di Titanio Titanium and Titanium alloys	HRSA Leghe resistenti al calore Heat resistant alloys	Acciai temprati Hardened steels 38/48 HRC	Acciai temprati Hardened steels 48/58 HRC	Acciai temprati Hardened steels 58/68 HRC	Codice cuspidi Inserts Code		Pagina catalogo Catalogue page
N1	N2	S1	S2	H1	H2	H3	Gruppo Materiali Materials Group		

V _c	f	V _c	f	V _c	f	V _c	f	V _c	f	V _c	f	V _c	f		
-	-	-	-	-	-	20	1	-	-	-	-	50GMTF			146
-	-	-	-	35	1	25	1	-	-	-	-	50DMTX			
150	6	70	5	-	-	-	-	-	-	-	-	50SMTL			
-	-	-	-	-	-	-	-	-	-	-	-	50CMTF			
-	-	-	-	-	-	20	1	-	-	-	-	50GMTF			147
-	-	-	-	35	1	25	1	-	-	-	-	50DMTX			
150	6	70	5	-	-	-	-	-	-	-	-	50SMTL			
-	-	-	-	-	-	-	-	-	-	-	-	50CMTF			

Ø 26	Ø 32	Ø 40		
0,160	0,180	0,200	1	Numero avanzamento Feed Number
0,200	0,220	0,260	2	
0,260	0,290	0,320	3	
0,320	0,340	0,400	4	
0,400	0,420	0,500	5	
0,500	0,550	0,650	6	
0,650	0,700	0,800	7	
0,800	0,900	1,000	8	

► I parametri di taglio indicati in tabella sono da considerarsi validi in condizioni macchina/pezzo ottimali
The cutting parameters shown in the table have to be considered valid in optimal machine/workpiece conditions

**A
02**

Famiglia prodotto Family product	Codice cuspidi Inserts Code	Acciaio debolmente legato Low-Alloyed Steel <800 N/mm ²	Acciaio mediamente legato Medium-Alloyed Steel 700/1000 N/mm ²	Acciaio fortemente legato High-Alloyed Steel 1000/1300 N/mm ²	Acciaio inossidabile Martensitico/Ferritico Stainless steel Martensitic/Ferritic	Acciaio inossidabile Austenitico Stainless steel Austenitic	Ghisa grigia Grey cast iron	Ghisa sferoidale Nodular cast iron
Gruppo Materiali Materials Group		P1	P2	P3	M1	M2	K1	K2

RECORD AG DRILL 603D		Inserto	Codice	V _c f		V _c f		V _c f		V _c f		V _c f		V _c f	
				m/min	mm/rev	m/min	mm/rev	m/min	mm/rev	m/min	mm/rev	m/min	mm/rev	m/min	mm/rev
RECORD AG DRILL 605D			60GMTF	125	7	85	6	60	5	-	-	-	-	-	-
			60DMTX	-	-	-	-	-	-	45	3	35	3	-	-
			60SMTL	-	-	-	-	-	-	-	-	-	-	-	-
			60CMTF	-	-	-	-	-	-	-	-	-	115	6	85
RECORD AG DRILL 607D			60GMTF	120	7	80	6	50	5	-	-	-	-	-	-
			60DMTX	-	-	-	-	-	-	45	3	30	3	-	-
			60SMTL	-	-	-	-	-	-	-	-	-	-	-	-
			60CMTF	-	-	-	-	-	-	-	-	-	115	6	80
RECORD AG DRILL 607D			60GMTF	115	5	75	4	50	3	-	-	-	-	-	-
			60DMTX	-	-	-	-	-	-	45	2	30	2	-	-
			60SMTL	-	-	-	-	-	-	-	-	-	-	-	-
			60CMTF	-	-	-	-	-	-	-	-	-	110	6	75

V_c: Velocità di taglio (m/min) | Cutting speed (m/min) f: Numero di avanzamento | Feed number

Avanzamento f_n (mm/g) per RECORD AG DRILL 600 | Feed f_n (mm/rev) for RECORD AG DRILL 600

Numero avanzamento Feed Number	Ø12	Ø16	Ø20
	1	0,080	0,100
2	0,100	0,130	0,160
3	0,130	0,160	0,200
4	0,160	0,200	0,260
5	0,200	0,260	0,320
6	0,260	0,320	0,400
7	0,320	0,400	0,500
8	0,400	0,500	0,650

Esempio della scelta dei dati di lavoro: 605D Ø 20 (60GMTF) | Gruppo materiale P1 | V_c = 120 m/min | f_n = 0,500 mm/giro (coefficiente f=7)
 Cutting data example: 605D Ø 20 (60GMTF) | Material group P1 | V_c = 120 m/min | f_n = 0,500 mm/rev (coefficient f=7)

PARAMETRI DI TAGLIO | CUTTING DATA

Punte a fissaggio meccanico | Indexable drills

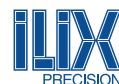

Alluminio e leghe di Alluminio Aluminum and Aluminum alloys	Materiali non ferrosi Non ferrous materials	Titanio e leghe di Titanio Titanium and Titanium alloys	HRSA Leghe resistenti al calore Heat resistant alloys	Acciai temprati Hardened steels 38/48 HRC	Acciai temprati Hardened steels 48/58 HRC	Acciai temprati Hardened steels 58/68 HRC	Codice cuspidi Inserts Code		Pagina catalogo Catalogue page
N1	N2	S1	S2	H1	H2	H3	Gruppo Materiali Materials Group		

V _c	f	V _c	f	V _c	f	V _c	f	V _c	f	V _c	f	V _c	f			
-	-	-	-	-	-	20	2	-	-	-	-	60GMTF			148	
-	-	-	-	30	2	20	2	-	-	-	-	60DMTX				
160	7	75	6	-	-	-	-	-	-	-	-	60SMTL				
-	-	-	-	-	-	-	-	-	-	-	-	60CMTF				
-	-	-	-	-	-	20	2	-	-	-	-	60GMTF			149	
-	-	-	-	30	2	20	2	-	-	-	-	60DMTX				
150	7	70	6	-	-	-	-	-	-	-	-	60SMTL				
-	-	-	-	-	-	-	-	-	-	-	-	60CMTF				
-	-	-	-	-	-	15	1	-	-	-	-	60GMTF			150	
-	-	-	-	30	1	20	1	-	-	-	-	60DMTX				
150	6	70	5	-	-	-	-	-	-	-	-	60SMTL				
-	-	-	-	-	-	-	-	-	-	-	-	60CMTF				

Ø 26	Ø 32	Ø 40		Numero avanzamento Feed Number
0,160	0,180	0,200	1	
0,200	0,220	0,260	2	
0,260	0,290	0,320	3	
0,320	0,340	0,400	4	
0,400	0,420	0,500	5	
0,500	0,550	0,650	6	
0,650	0,700	0,800	7	
0,800	0,900	1,000	8	

► I parametri di taglio indicati in tabella sono da considerarsi validi in condizioni macchina/pezzo ottimali
The cutting parameters shown in the table have to be considered valid in optimal machine/workpiece conditions

**A
02**

Famiglia prodotto Family product		Codice inserto Inserts Code	Acciaio debolmente legato Low-Alloyed Steel <800 N/mm ²	Acciaio mediamente legato Medium-Alloyed Steel 700/1000 N/mm ²	Acciaio fortemente legato High-Alloyed Steel 1000/1300 N/mm ²	Acciaio inossidabile Martensitico/Ferritico Stainless steel Martensitic/Ferritic	Acciaio inossidabile Austenitico Stainless steel Austenitic	Ghisa grigia Grey cast iron	Ghisa sferoidale Nodular cast iron
Gruppo Materiali Materials Group			P1	P2	P3	M1	M2	K1	K2

				V _c	f	V _c	f	V _c	f	V _c	f	V _c	f	V _c	f	V _c	f
RECORD INDEX DRILL GTR3D - GTR4D			WCEX.LC AGP25-35	170	5	-	-	-	-	-	-	-	-	-	-	-	-
			WCEX.MC AGP25-35	170	4	130	4	95	3	85	3	60	3	150	5	110	4
RECORD INDEX DRILL GSQ3D - GSQ4D			SPKX.MC AGP25-35	170	5	130	5	95	4	85	3	60	2	150	7	110	5
			SPKX.MC AGU30	180	5	150	5	110	4	110	3	80	2	180	7	130	5
			SPHX.LN AGN010	-	-	-	-	-	-	-	-	-	-	-	-	-	-

V_c: Velocità di taglio (m/min) | Cutting speed (m/min) f: Numero di avanzamento | Feed number

Avanzamento f_n (mm/g) per RECORD INDEX DRILL GTR.. | Feed f_n (mm/rev) for RECORD INDEX DRILL GTR..

		Ø 16 - 20	Ø 20,5 - 25	Ø 25,5 - 30	Ø 31 - 41	Ø 42 - 50
Numero avanzamento Feed Number	1	0,04 - 0,06	0,04 - 0,07	0,05 - 0,08	0,06 - 0,10	0,07 - 0,13
	2	0,05 - 0,07	0,06 - 0,08	0,07 - 0,09	0,10 - 0,14	0,12 - 0,17
	3	0,05 - 0,09	0,06 - 0,12	0,07 - 0,13	0,10 - 0,16	0,12 - 0,20
	4	0,06 - 0,10	0,07 - 0,12	0,09 - 0,15	0,11 - 0,18	0,15 - 0,28
	5	0,06 - 0,13	0,07 - 0,12	0,08 - 0,18	0,14 - 0,26	0,18 - 0,35
	6	0,07 - 0,13	0,08 - 0,12	0,10 - 0,18	0,15 - 0,28	0,20 - 0,40

Esempio della scelta dei dati di lavoro: GTR3D Ø 20 (WCEX.LC) | Gruppo materiale **P1** | V_c = 170 m/min | f_n = **0,13 mm/giro** (coefficiente f=5)
Cutting data example: GTR3D Ø 20 (WCEX.LC) | Working material group **P1** | V_c = 170 m/min | f_n = **0,13 mm/rev** (coefficiente f=5)

PARAMETRI DI TAGLIO | CUTTING DATA

Punte a fissaggio meccanico | Indexable drills

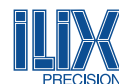

Alluminio e leghe di Alluminio Aluminum and Aluminum alloys	Materiali non ferrosi Non ferrous materials	Titanio e leghe di Titanio Titanium and Titanium alloys	HRSA Leghe resistenti al calore Heat resistant alloys	Acciai temprati Hardened steels 38/48 HRC	Acciai temprati Hardened steels 48/58 HRC	Acciai temprati Hardened steels 58/68 HRC	Codice inserto Inserts Code		Pagina catalogo Catalogue page
N1	N2	S1	S2	H1	H2	H3	Gruppo Materiali Materials Group		

V _c	f	V _c	f	V _c	f	V _c	f	V _c	f	V _c	f	V _c	f				
-	-	-	-	-	-	-	-	-	-	-	-	-	-	WCEX.LC AGP25-35			GTR3D 161 GTR4D 163
200	6	140	4	35	2	30	2	-	-	-	-	-	-	WCEX.MC AGP25-35			
-	-	-	-	35	1	30	1	-	-	-	-	-	-	SPKX.MC AGP25-35			GSQ3D 162 GSQ4D 164
-	-	-	-	35	1	30	1	-	-	-	-	-	-	SPKX.MC AGU30			
250	7	160	6	-	-	-	-	-	-	-	-	-	-	SPHX.LN AGN010			

Avanzamento f_n (mm/g) per RECORD INDEX DRILL GSQ.. | Feed f_n (mm/rev) for RECORD INDEX DRILL GSQ..

		Ø 16 - 20	Ø 20,5 - 25	Ø 25,5 - 30	Ø 31 - 41	Ø 42 - 50
Numero avanzamento Feed Number	1	0,06 - 0,10	0,06 - 0,12	0,07 - 0,13	0,08 - 0,15	0,08 - 0,16
	2	0,06 - 0,12	0,08 - 0,15	0,09 - 0,16	0,10 - 0,17	0,11 - 0,19
	3	0,06 - 0,14	0,08 - 0,18	0,10 - 0,22	0,12 - 0,23	0,14 - 0,24
	4	0,08 - 0,14	0,10 - 0,18	0,12 - 0,22	0,12 - 0,24	0,15 - 0,25
	5	0,08 - 0,15	0,10 - 0,19	0,12 - 0,23	0,15 - 0,24	0,16 - 0,26
	6	0,08 - 0,16	0,10 - 0,20	0,12 - 0,24	0,15 - 0,25	0,17 - 0,26
	7	0,09 - 0,17	0,12 - 0,20	0,15 - 0,25	0,16 - 0,28	0,18 - 0,30

Esempio della scelta dei dati di lavoro: GSQ3D Ø 20 (SPKX.MC) | Gruppo materiale **P1** | V_c = 170 m/min | f_n = **0,15 mm/giro** (coefficiente f=5)
Cutting data example: GSQ3D Ø 20 (SPKX.MC) | Working material group **P1** | V_c = 170 m/min | f_n = **0,15 mm/rev** (coefficient f=5)

► I parametri di taglio indicati in tabella sono da considerarsi validi in condizioni macchina/pezzo ottimali
 The cutting parameters shown in the table have to be considered valid in optimal machine/workpiece conditions

**A
02**

Famiglia prodotto Family product		Codice inserto Inserts Code	Acciaio debolmente legato Low-Alloyed Steel <800 N/mm ²	Acciaio mediamente legato Medium-Alloyed Steel 700/1000 N/mm ²	Acciaio fortemente legato High-Alloyed Steel 1000/1300 N/mm ²	Acciaio inossidabile Martensitico/Ferritico Stainless steel Martensitic/Ferritic	Acciaio inossidabile Austenitico Stainless steel Austenitic	Ghisa grigia Grey cast iron	Ghisa sferoidale Nodular cast iron
Gruppo Materiali Materials Group			P1	P2	P3	M1	M2	K1	K2

		V _c		f		V _c		f		V _c		f		V _c		f		V _c		f	
RECORD INDEX DRILL DHTR		WCEX.LC AGP25-35	130	5	-	-	-	-	-	-	-	-	-	-	-	-	-	-	-	-	-
		WCEX.MC AGP25-35	130	5	100	5	80	4	70	2	60	1	130	6	100	5					
RECORD INDEX DRILL DHMTR		WCEX.LC AGP25-35	130	4	-	-	-	-	-	-	-	-	-	-	-	-	-	-	-	-	-
		WCEX.MC AGP25-35	130	4	100	3	80	1	70	2	60	2	130	5	100	4					

V_c: Velocità di taglio (m/min) | Cutting speed (m/min) f: Numero di avanzamento | Feed number

Avanzamento f_n (mm/g) per RECORD INDEX DRILL DHTR | Feed f_n (mm/rev) for RECORD INDEX DRILL DHTR

		Ø 25	Ø 26 - 30	Ø 31 - 40	Ø 41 - 45
Numero avanzamento Feed Number	1	0,04 - 0,07	0,04 - 0,11	0,06 - 0,12	0,08 - 0,14
	2	0,04 - 0,06	0,06 - 0,12	0,08 - 0,13	0,09 - 0,15
	3	0,04 - 0,06	0,07 - 0,12	0,08 - 0,13	0,09 - 0,15
	4	0,05 - 0,07	0,05 - 0,07	0,06 - 0,08	0,06 - 0,10
	5	0,06 - 0,10	0,07 - 0,11	0,08 - 0,12	0,10 - 0,14
	6	0,07 - 0,13	0,07 - 0,15	0,08 - 0,16	0,10 - 0,18

Esempio della scelta dei dati di lavoro: DHTR Ø 30 (WCEX.LC) | Gruppo materiale **P1** | V_c = 130 m/min | f_n = **0,11 mm/giro** (coefficiente f=5)
Cutting data example: DHTR Ø 30 (WCEX.LC) | Working material group **P1** | V_c = 130 m/min | f_n = **0,11 mm/rev** (coefficient f=5)

PARAMETRI DI TAGLIO | CUTTING DATA

Punte a fissaggio meccanico | Indexable drills



Alluminio e leghe di Alluminio Aluminum and Aluminum alloys	Materiali non ferrosi Non ferrous materials	Titanio e leghe di Titanio Titanium and Titanium alloys	HRSA Leghe resistenti al calore Heat resistant alloys	Acciai temprati Hardened steels 38/48 HRC	Acciai temprati Hardened steels 48/58 HRC	Acciai temprati Hardened steels 58/68 HRC	Codice inserto Inserts Code		Pagina catalogo Catalogue page
N1	N2	S1	S2	H1	H2	H3	Gruppo Materiali Materials Group		

V_c	f	V_c	f	V_c	f	V_c	f	V_c	f	V_c	f	V_c	f				
-	-	-	-	-	-	-	-	-	-	-	-	-	-	WCEX.LC AGP25-35			165
150	5	130	5	35	1	30	1	-	-	-	-	-	WCEX.MC AGP25-35				
-	-	-	-	-	-	-	-	-	-	-	-	-	-	WCEX.LC AGP25-35			168
150	4	130	3	30	1	25	1	-	-	-	-	-	WCEX.MC AGP25-35				

Avanzamento f_n (mm/g) per RECORD INDEX DRILL DHMTR | Feed f_n (mm/rev) for RECORD INDEX DRILL DHMTR

Numero avanzamento Feed Number		Ø45 - 60	Ø 60-75	Ø 75 - 100	Ø 100- 105	Ø 105 - 150	Ø 150 - 180
	1	0,05 - 0,07	0,06 - 0,08	0,06 - 0,10	0,09 - 0,13	0,06 - 0,08	0,06 - 0,10
	2	0,05 - 0,11	0,06 - 0,12	0,08 - 0,14	0,10 - 0,18	0,06 - 0,12	0,08 - 0,14
	3	0,06 - 0,11	0,08 - 0,12	0,10 - 0,14	0,12 - 0,20	0,08 - 0,12	0,10 - 0,14
	4	0,06 - 0,15	0,08 - 0,16	0,10 - 0,18	0,12 - 0,22	0,08 - 0,16	0,10 - 0,18
	5	0,07 - 0,15	0,08 - 0,16	0,10 - 0,25	0,12 - 0,26	0,08 - 0,16	0,10 - 0,25

Esempio della scelta dei dati di lavoro: DHMTR Ø 60 (WCEX.LC) | Gruppo materiale **P1** | $V_c = 130$ m/min | $f_n = 0,15$ mm/giro (coefficiente f=4)
Cutting data example: DHMTR Ø 60 (WCEX.LC) | Working material group **P1** | $V_c = 130$ m/min | $f_n = 0,15$ mm/rev (coefficient f=4)

► I parametri di taglio indicati in tabella sono da considerarsi validi in condizioni macchina/pezzo ottimali
 The cutting parameters shown in the table have to be considered valid in optimal machine/workpiece conditions