

UTENSILI IN METALLO DURO BRASATI



OUTILS DE TOURNAGE EN MÉTAL DUR BRASÉS

CARBIDE TIPPED TURNING TOOLS

GELÖTETE HARTMETALL- DREHWERKZEUGE

Tallicarb

Tallicarb

UTENSILI PER TORNIO

OUTILS DE TOURNAGE EN MÉTAL DUR BRASÉS

CARBIDE TIPPED TURNING TOOLS

GELÖTETE HARTMETALL- DREHWERKZEUGE

QUALITÀ K10/P25

NUANCES K10/P25/K05/P10/P40

GRADES K10/P25/K05/P10/P40

SORTEN K10/P25/K05/P10/P40

ISO1

UTENSILE SGROSSATORE

Outil droit à chariotier

Bar turning tool

Gerader Schruppstahl

UNI 4102

110

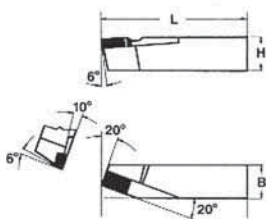

ESECUZIONE DESTRA E SINISTRA

Exécution droite et gauche

Right and left version

Rechte und linke Ausführung

PLACCHETTA Plaquette - Carbide tip Schneidplatte	H x B x L	€
C 8	10 x 10 x 90	9,57
C 10	12 x 12 x 100	12,35
C 12	16 x 16 x 110	14,86
C 16	20 x 20 x 125	19,20
C 20	25 x 25 x 140	27,75
C 25	32 x 32 x 170	45,40
C 32	40 x 40 x 200	80,80

ISO2

UTENSILE SGROSSATORE 45°

Outil à chariotier 45°

45° cranked turning tool

45° Gebogener Schruppstahl

UNI 4103

111

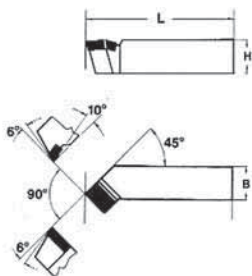
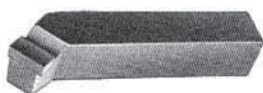

ESECUZIONE DESTRA E SINISTRA

Exécution droite et gauche

Right and left version

Rechte und linke Ausführung

PLACCHETTA Plaquette - Carbide tip Schneidplatte	H x B x L	€
C 8	10 x 10 x 90	9,57
C 10	12 x 12 x 100	12,35
C 12	16 x 16 x 110	14,86
C 16	20 x 20 x 125	19,20
C 20	25 x 25 x 140	27,75
C 25	32 x 32 x 170	45,40
C 32	40 x 40 x 200	80,80

ISO4

UTENSILE FRONTALE

Outil à planer

Straight facing tool

Kopfstahl

UNI 4107

127

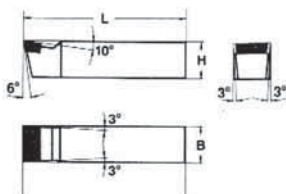

PLACCHETTA Plaquette - Carbide tip Schneidplatte	H x B x L	€
C 10	10 x 10 x 90	12,35
C 12	12 x 12 x 100	16,25
C 16	16 x 16 x 110	21,25
C 20	20 x 20 x 125	29,10
C 25	25 x 25 x 140	44,60
C 12	20 x 12 x 125	18,85
C 16	25 x 16 x 140	28,25
C 20	32 x 20 x 170	39,45
C 25	40 x 25 x 200	69,00

UTENSILI PER TORNIO

OUTILS DE TOURNAGE EN MÉTAL DUR BRASÉS

CARBIDE TIPPED TURNING TOOLS

GELÖTETE HARTMETALL- DREHWERKZEUGE

QUALITÀ K10/P25

NUANCES K10/P25/K05/P10/P40

GRADES K10/P25/K05/P10/P40

SORTEN K10/P25/K05/P10/P40

ISO8

UTENSILE PER FORI PASSANTI

Outil à aléser

Boring tool

Innenschrupp-stahl

UNI 4110
131

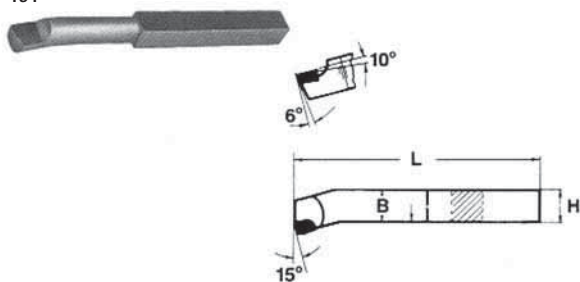

PLACCHETTA Plaquette - Carbide tip Schneidplatte	H x B x L	€
A 6	10 x 10 x 150	11,95
A 8	12 x 12 x 180	14,22
A 10	16 x 16 x 210	17,25
A 12	20 x 20 x 250	21,70
A 16	25 x 25 x 300	31,05
A 20	32 x 32 x 355	49,40
A 25	40 x 40 x 355	91,40

ISO9

UTENSILE PER FORI CIECHI

Outil à dresser les founds

Cranked internal facing tool

Inneckstahl

UNI 4111
136

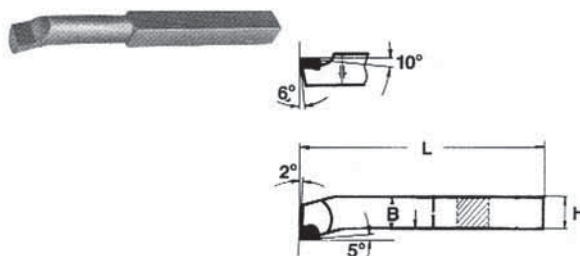

PLACCHETTA Plaquette - Carbide tip Schneidplatte	H x B x L	€
A 6	10 x 10 x 150	11,95
A 8	12 x 12 x 180	14,22
A 10	16 x 16 x 210	17,25
A 12	20 x 20 x 250	21,70
A 16	25 x 25 x 300	31,05
A 20	32 x 32 x 355	49,40
A 25	40 x 40 x 355	91,40

975

UTENSILE FINITORE

Outil droite à finir

Straight finishing tool

Schlichstahl

UNI 4105

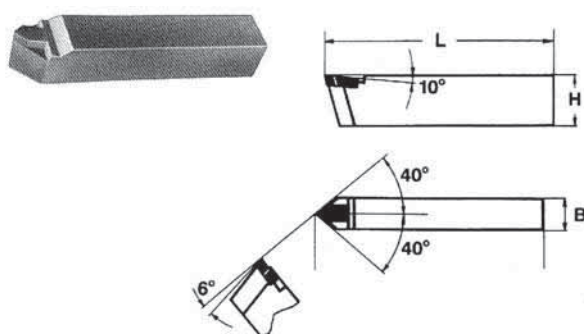

PLACCHETTA Plaquette - Carbide tip Schneidplatte	H x B x L	€
E 4	10 x 10 x 90	9,80
E 5	12 x 12 x 100	12,70
E 6	16 x 16 x 110	15,25
E 8	20 x 20 x 125	18,70
E 10	25 x 25 x 140	26,15
E 12	32 x 32 x 170	45,40
E 16	40 x 40 x 200	80,80

UTENSILI PER TORNIO

OUTILS DE TOURNAGE EN MÉTAL DUR BRASÉS
CARBIDE TIPPED TURNING TOOLS
GELÖTETE HARTMETALL- DREHWERKZEUGE

QUALITÀ K10/P25

NUANCES K10/P25/K05/P10/P40
GRADES K10/P25/K05/P10/P40
SORTEN K10/P25/K05/P10/P40

164

UTENSILE PER GOLE TRAPEZOIDALI
Outil pour gorges des poulies
Vee-pulley grooving tool
Keilriemen- Profistahl



$\alpha = 34^\circ - 36^\circ - 38^\circ - 40^\circ$

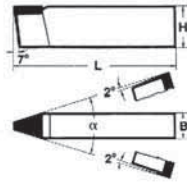

PLACCHETTA Plaquette - Carbide tip Schneidplatte	H x B x L	€
CR 12	20 x 12 x 125	25,00
CR 16	25 x 16 x 140	31,85
CR 20	32 x 20 x 170	43,10
CR 25	40 x 25 x 200	86,10

165

UTENSILE PER COPIA
Outil pour tours à copier
Copying lathe tool
Kopierdreh meißel



ESECUZIONE DESTRA E SINISTRA
Exécution droite et gauche
Right and left version
Rechte und linke Ausführung

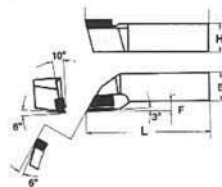

PLACCHETTA Plaquette - Carbide tip Schneidplatte	H x B x L	€
C 12	16 x 16 x 125	18,55
C 16	20 x 20 x 140	24,65
C 20	25 x 25 x 170	37,65

166

UTENSILE FILETTATORE ESTERNO
Outil à fileter extérieur
External threading tool
Aussengewindestahl



$\alpha = 60^\circ - 55^\circ$

ESECUZIONE DESTRA E SINISTRA
Exécution droite et gauche
Right and left version
Rechte und linke Ausführung

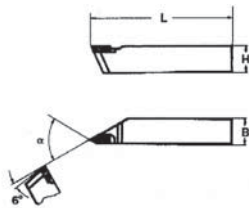

PLACCHETTA Plaquette - Carbide tip Schneidplatte	H x B x L	€
E 4	16 x 10 x 110	14,08
E 5	20 x 12 x 125	18,20
E 6	25 x 16 x 140	23,15
E 8	32 x 20 x 170	37,65

167

UTENSILE FILETTATORE INTERNO
Outil à fileter intérieur
Internal threading tool
Innengewindestahl



$\alpha = 60^\circ - 55^\circ$

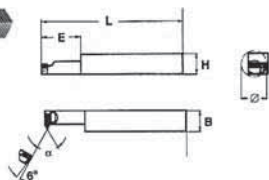

PLACCHETTA Plaquette - Carbide tip Schneidplatte	H x B x L	€
E 4	10 x 10 x 140	13,22
E 5	12 x 12 x 160	15,55
E 6	16 x 16 x 180	19,35
E 8	20 x 20 x 210	24,50
E 10	25 x 25 x 250	36,10

UTENSILI ORIENTABILI

OUTIL ORIENTABLES EN MÉTAL DUR BRASÉS

CARBIDE TIPPED ROTARY TOOLS

SCHWENKBARE HARTMETALLBESTÜCKTE WERKZEUGE

QUALITÀ K10/P25/K05/P10/P40

NUANCES K10/P25/K05/P10/P40

GRADES K10/P25/K05/P10/P40

SORTEN K10/P25/K05/P10/P40

125

UTENSILE SGROSSATORE DESTRO

Outil d'ébauche à droite

R.H. roughing tool

Rechter Schruppstahl

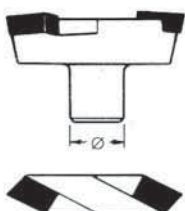

126

UTENSILE SGROSSATORE DESTRO-SINISTRO

Outil d'ébauche à droite et à gauche

R.H. and L. H. roughing tool

Linker und rechter Schruppstahl

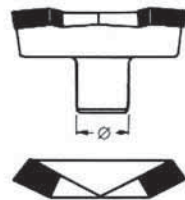

127

UTENSILE FINITORE

Outil de finition

Finishing tool

Schlichtmesser



128

UTENSILE A TESTA PIATTA

Outil pelle

Plain form tool

Kopfmesser

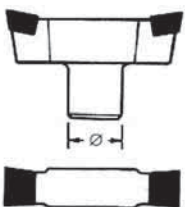

PLACCHETTA Plaquette - Carbide tip Schneidplatte	Ø	€
C 12	12	29,05
C 12	14	31,85
C 16	16	38,20
C 20	18	58,10

PLACCHETTA Plaquette - Carbide tip Schneidplatte	Ø	€
C 12	12	29,05
C 12	14	31,85
C 16	16	38,20
C 20	18	58,10

PLACCHETTA Plaquette - Carbide tip Schneidplatte	Ø	€
E 4	12	29,05
E 5	14	31,85
E 6	16	37,10
E 8	18	56,40

PLACCHETTA Plaquette - Carbide tip Schneidplatte	Ø	€
C 12	12	29,05
C 12	14	31,85
C 16	16	38,20

UTENSILI PER INTERNI

OUTILS EN MÉTAL DUR BRASÉS POUR PORTE OUTILS
 CARBIDE TIPPED TOOLS FOR TOOL-HOLDERS
 HARTMETALLBESTÜCKTE WERZUEGE FÜR WERKEZEUGHALTER

QUALITÀ K10/P25

NUANCES K10/P25
 GRADES K10/P25
 SORTEN K10/P25

142

UTENSILE SGROSSATORE 60°
 Outil à charioter à 60°
 60° roughing tool
 60° Schrumpmesser

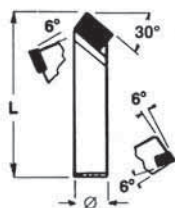

PLACCHETTA Plaquette - Carbide tip Schneidplatte	Ø x L	€
C 5	4 x 18	7,62
C 5	5 x 20	8,08
C 6	7 x 25	8,60
C 8	8 x 30	9,57
C 10	10 x 45	11,55
C 12	12 x 50	13,28
C 16	16 x 70	18,65

143

UTENSILE SGROSSATORE 90°
 Outil à charioter à 90°
 90° roughing tool
 90° Schrumpmesser

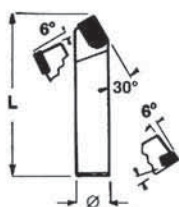

PLACCHETTA Plaquette - Carbide tip Schneidplatte	Ø x L	€
C 5	4 x 18	7,62
C 5	5 x 20	8,08
C 6	7 x 25	8,60
C 8	8 x 30	9,57
C 10	10 x 45	11,55
C 12	12 x 50	13,28
C 16	16 x 70	18,65

144

UTENSILE FINITORE
 Outil de finition
 Finishing tool
 Schlichtwerkzeug

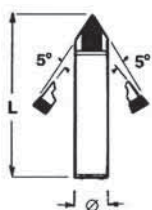

PLACCHETTA Plaquette - Carbide tip Schneidplatte	Ø x L	€
E 4	4 x 18	7,62
E 4	5 x 20	8,08
E 4	7 x 25	8,60
E 5	8 x 30	9,57
E 6	10 x 45	11,55
E 8	12 x 50	13,28
E 10	16 x 70	18,65

145

UTENSILE FILETTATORE 60°
 Outil à filiter à 60°
 60° threading tool
 60° Gewindeschneidwerkzeug

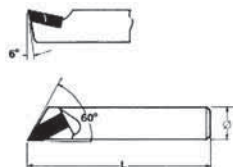

PLACCHETTA Plaquette - Carbide tip Schneidplatte	Ø x L	€
E 4	4 x 18	7,62
E 4	5 x 20	8,08
E 4	7 x 25	8,60
E 5	8 x 30	9,57
E 6	10 x 45	11,55
E 8	12 x 50	13,28
E 10	16 x 70	18,65